

Mini slides DGSL

FESTO



Festo Core Range
Solves the majority of your automation tasks

Worldwide: Quickest delivery – wherever, whenever
Simply good: Expected high Festo quality
Fast: Easy and fast to select

With the Festo Core Range, we have selected the most important products and functions from our broad product catalogue, and added the quickest delivery.
The Core Range offers you the best value for your automation tasks.

Just look
for the
star!

Key features

General

- Double-acting drives
- Wide range of mounting options
- System product for handling and assembly technology
- Highly flexible thanks to versatile assembly and mounting options on:
 - Drive body, slide, yoke plate

The technology in detail



[1] Cushioning



- Choice of five cushioning types:
 - Elastic cushioning without metal end position (P)
 - Elastic cushioning without metal end position, short design (E)
 - Elastic cushioning with metal end position (P1)
 - Shock absorber (Y3)
 - Shock absorber with reducing sleeve (Y11)
- Alternative:
 - Without cushioning (N)

[2] Cover

→ Page 47



- The cover stops foreign parts or dirt getting into the guide
- The cover comes in different lengths and can be shortened as required by the customer

[3] Coarse stroke adjustment

→ Page 10



- The end stop for the advanced end position can be adjusted mechanically, for example to shorten the stroke

[4] Clamping unit

→ Page 40



- Mechanical clamping for fixing the slide in any position; frictional locking (C)

[4] End-position locking

→ Page 40



- Mechanical locking when the end position is reached, for fixing the slide in the unpressurised, retracted state; positive locking (E3)

[5] Innovative guide unit



- Wide roller track, providing extremely high rigidity
- High load capacity
- High precision
- Housing and steel slide form a guide, there are no accumulative tolerances

[6] Position sensing



- Proximity switches can be integrated, so there are no projecting parts
- Two slots for mounting
- Clearly visible from the side and from above

[7] Supply ports

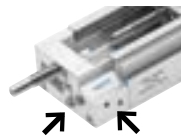

- Choice of two sides:
 - On the front
 - On the side

System example

The technology in detail

Intermediate-position module

→ Page 48

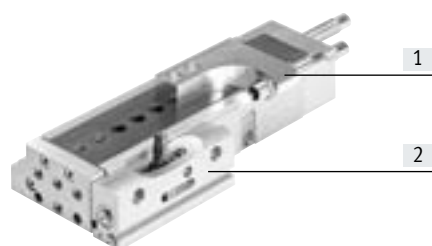

The intermediate-position module enables an additional adjustable position within the stroke range.

- [1] Shock absorber retainer
- [2] Intermediate-position module

- The symmetrical design means that the intermediate position can be approached when advancing or retracting, depending on the assembly
- Can be travelled through from the end position
- Possible to continue on directly from the intermediate position
- Easy to assemble
- Sensing of the stop lever position possible

System product for handling and assembly technology

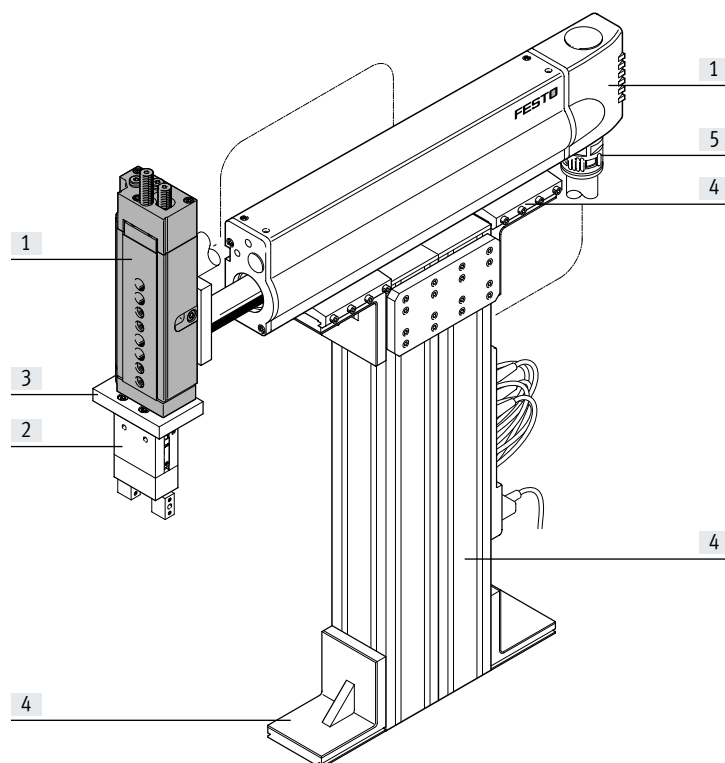

System components and accessories

	Description	→ Page/Internet
[1] Drives	Wide range of combinations possible within handling and assembly technology	drive
[2] Grippers	Wide range of variations possible within handling and assembly technology	gripper
[3] Adapters	For drive/drive connections	54
	For drive/gripper connections	adapter kit
[4] Basic components	Profiles and profile connections as well as profile/drive connections	basic component
[5] Installation components	For a clear, safe layout of electrical cables and tubing	installation component
- Axes	Wide range of combinations possible within handling and assembly technology	axis
- Motors	Servo and stepper motors, with or without gearbox	motor

Peripherals overview

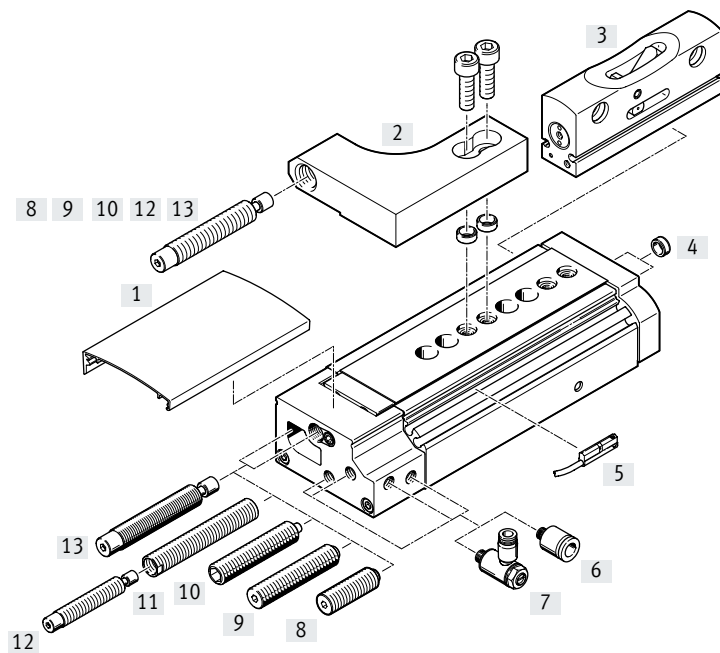

Note
 Operation without cushioning components is not permitted.

Accessories	Description	→ Page/Internet
[1] Cover DADS	<ul style="list-style-type: none"> For protection, to stop foreign parts or dirt getting into the guide The cover can be shortened as required by the customer 	47
[2] Shock absorber retainer DADP	<ul style="list-style-type: none"> Attachment for the shock absorber For positioning and cushioning the intermediate position 	50
[3] Intermediate-position module DADM	With stop lever for the intermediate position	48
[4] Centring sleeve ZBH	For centring loads and attachments (centring sleeves are included in the scope of delivery of the mini slide)	52
[5] Proximity switch SME/SMT-10	For position sensing. Can be integrated in the sensor slot, which means there is no projection	53
[6] Push-in fitting QSM	For connecting tubing with standard O.D.	52
[7] One-way flow control valve GRLA	For regulating speed	52
[8] Cushioning E	<ul style="list-style-type: none"> Elastic stop for medium loads at medium speed 	51
[9] Cushioning P	<ul style="list-style-type: none"> Elastic stop for medium loads at medium speed 	51
[10] Cushioning with stop P1	Precision metal stop for small loads at low speed	51
[11] Reducing sleeve DAYH	For installing a smaller shock absorber. For applications in which the cushioning energy is between cushioning Y3 and P1	51
[12] Shock absorber DYSW	→ Page (shock absorber selection)	51
[13] Cushioning with shock absorber Y3	For large loads and high speed. Ensures precise, metal-to-metal contact after the cushioning	51

Type codes

001	Series	
DGSL	Mini slide, double-acting	

002	Size	
4	4	
6	6	
8	8	
10	10	
12	12	
16	16	
20	20	
25	25	

003	Stroke	
...	10 ... 200	

004	Clamping unit	
	None	
C	Attached	

005	End-position locking	
	None	
E3	With retracted piston rod	

006	Cushioning	
N	No cushioning	
P	Elastic cushioning rings/plates on both sides	
P1	Elastomer cushioning, adjustable on both sides, with fixed stop	
Y3	Shock absorber, self-adjusting, progressive, at both ends	
E	Elastomer cushioning, short, on both sides	
Y11	Shock absorber, self-adjustable, progressive at both ends, with reducing sleeve	

007	Position sensing	
A	For proximity sensor	

Data sheet

Function

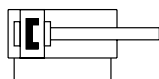

- \varnothing - Size
4 ... 25
- | - Stroke length
10 ... 200 mm

Sets of wearing parts

→ Page 45



General technical data		4	6	8	10	12	16	20	25	
Size		4	6	8	10	12	16	20	25	
Pneumatic connection		M3			M5		G1/8			
Design		Scotch yoke system								
Guide		Ball bearing cage guide								
Type of mounting		Via through-hole With female thread								
Cushioning	P	Elastic cushioning without metal end position, at both ends								
	E	Elastic cushioning without metal end position, at both ends, short design								
	P1	Elastic cushioning with metal end position, at both ends, adjustable								
	Y3	-				Progressive shock absorber, at both ends				
	Y11	-				Progressive shock absorber with reducing sleeve, at both ends				
	N	No cushioning								
Position sensing		Via proximity switch								
Mounting position		Any								
Max. advancing speed	[m/s]	0.5			0.8					
Max. retracting speed	[m/s]	0.5			0.8					
Repetition accuracy	P1/Y3	[mm]	±0.01							
	P	[mm]	0.3							

Operating and environmental conditions		4	6	8	10	12	16	20	25
Size		4	6	8	10	12	16	20	25
Operating medium		Compressed air to ISO 8573-1:2010 [7:4:4]							
Note on the operating/pilot medium		Lubricated operation possible (in which case lubricated operation will always be required)							
Min. operating pressure	[MPa]	0.25	0.15			0.1			
	[bar]	2.5	1.5			1			
Max. operating pressure ¹⁾	[MPa]	0.8							
	[bar]	8							
Ambient temperature ²⁾	[°C]	0 ... +60							

1) Note max. operating pressure in combination with the intermediate-position module DADM-EP → Internet: dadm
 2) Note operating range of proximity switches

Piston diameter, forces and impact energy		4	6	8	10	12	16	20	25	
Size		4	6	8	10	12	16	20	25	
Piston \varnothing	[mm]	6	8	10	12	16	20	25	32	
Theoretical force at 0.6 MPa (6 bar), advancing	[N]	17	30	47	68	121	188	295	483	
Theoretical force at 0.6 MPa (6 bar), retracting	[N]	13	23	40	51	104	158	247	415	
Impact energy in the end positions	P, E	[Nm]	0.015	0.05	0.08	0.12	0.25	0.35	0.45	0.55
	P1	[Nm]	0.005	0.02	0.03	0.04	0.06	0.12	0.2	0.25
	Y3	[Nm]	-	-	0.8	1.3	2.5	4	8	12
	1)	[Nm]	-	-	-	0.8	1.3	2.5	4	8

1) With reducing sleeve and next smaller shock absorber.

Data sheet

Weight [g] Size	Stroke	4	6	8	10	12	16	20	25
Product weight without cushioning component									
	10	82	158	235	396	604	896	1535	2520
	20	93	179	263	434	660	954	1649	2670
	30	104	197	289	470	711	1008	1746	2824
	40	–	215	313	507	762	1072	1857	2983
	50	–	232	370	548	813	1143	1991	3137
	80	–	–	454	727	1112	1365	2295	4019
	100	–	–	–	813	1229	1712	2921	4519
	150	–	–	–	–	1499	2034	3620	5344
	200	–	–	–	–	–	–	4248	6139
Moving mass without cushioning component									
	10	31	68	101	163	256	403	660	998
	20	34	76	111	180	279	432	710	1052
	30	38	83	121	194	299	459	750	1115
	40	–	90	130	208	320	486	801	1181
	50	–	99	152	226	340	519	858	1244
	80	–	–	185	299	456	618	998	1567
	100	–	–	–	334	507	776	1254	1761
	150	–	–	–	–	614	910	1566	2102
	200	–	–	–	–	–	–	1807	2432
Cushioning component									
	P	2	3.6	6	14	23	45.6	82.4	106
	E	1	2	3	9	12	15	31	40
	P1	1.6	3	5	12	19.7	39.6	77.3	104
	Y3	–	–	6	11	21	42	67	91
	1)	–	–	–	18	33	52	91	131

1) With reducing sleeve and next smaller shock absorber.

Materials

Sectional view

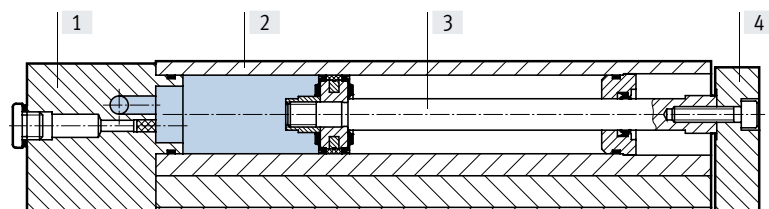

Mini slide	
[1] Cover	Anodised aluminium
[2] Housing	Anodised aluminium
[3] Piston rod	High-alloy steel
[4] Yoke plate	Anodised aluminium
– Guide	Tempered steel
– Seals	Thermoplastic rubber, hydrogenated nitrile rubber, nitrile rubber
Note on materials	Free of copper and PTFE

Data sheet

Possible combinations without adapter plate

Pick and place

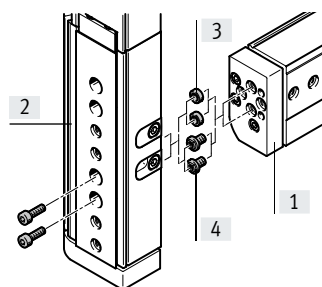
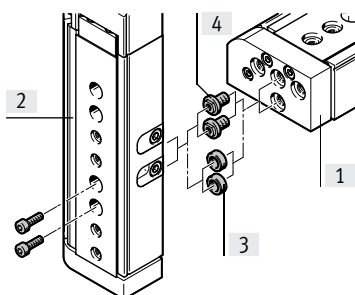

Piggy-back assembly

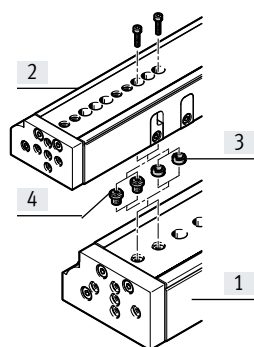

- [3] Centring sleeve ZBH
- [4] Connector sleeve ZBV

Mounting example with connector sleeve ZBV

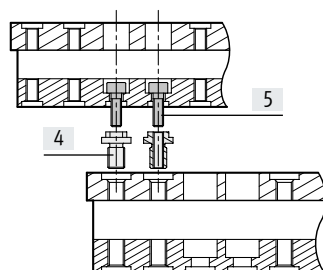

- [4] Connector sleeve ZBV²⁾
- [5] Screw

	[1] Basic drive	Size							
		4	6	8	10	12	16	20	25
[2] Add-on drive	4	2x M3x7 2x ZBH-5 ¹⁾	2x M3x10 2x ZBH-5 ¹⁾	ZBV-M4-7 ²⁾	ZBV-M4-7 ²⁾	-	-	-	-
	6	-	2x M3x10 2x ZBH-5 ¹⁾	ZBV-M4-7 ²⁾	ZBV-M4-7 ²⁾	-	-	-	-
	8	-	-	2x M4x12 2x ZBH-7 ¹⁾	2x M4x12 2x ZBH-7 ¹⁾	ZBV-M5-7 ²⁾	ZBV-M5-7 ²⁾	-	-
	10	-	-	-	2x M4x14 2x ZBH-7 ¹⁾	ZBV-M5-7 ²⁾	ZBV-M5-7 ²⁾	-	-
	12	-	-	-	-	2x M5x14 2x ZBH-7 ¹⁾	2x M5x16 2x ZBH-7 ¹⁾	ZBV-M6-9 ²⁾	ZBV-M6-9 ²⁾
	16	-	-	-	-	-	2x M5x18 2x ZBH-7 ¹⁾	ZBV-M6-9 ²⁾	ZBV-M6-9 ²⁾
	20	-	-	-	-	-	-	2x M6x20 2x ZBH-9 ¹⁾	2x M6x20 2x ZBH-9 ¹⁾
	25	-	-	-	-	-	-	-	2x M6x30 2x ZBH-9 ¹⁾

1) Centring sleeves ZBH are included in the scope of delivery of the mini slide DGSL

2) Connector sleeves ZBV → page 52

Data sheet

Parallelism [mm]

The term parallelism refers to the accuracy of alignment between the mounting surface and the slide surface.

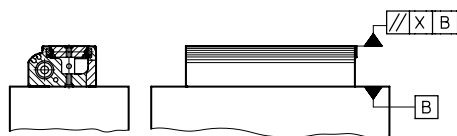

Size	Stroke [mm]	4	6	8	10	12	16	20	25
Parallelism X	10	0.02	0.02	0.02	0.02	0.02	0.02	0.02	0.02
	20	0.02	0.02	0.02	0.02	0.025	0.025	0.025	0.025
	30	0.025	0.025	0.025	0.025	0.025	0.025	0.025	0.03
	40	–	0.025	0.025	0.025	0.025	0.03	0.03	0.035
	50	–	0.03	0.03	0.03	0.03	0.035	0.035	0.04
	80	–	–	0.035	0.035	0.035	0.04	0.04	0.045
	100	–	–	–	0.045	0.045	0.05	0.05	0.055
	150	–	–	–	–	–	0.075	0.075	0.08
200	–	–	–	–	–	–	–	0.08	

Linearity [mm]

The term linearity refers to the accuracy of alignment between the mounting surface and the slide surface as a function of the stroke.

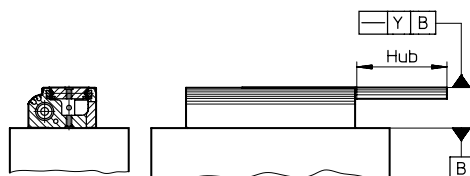
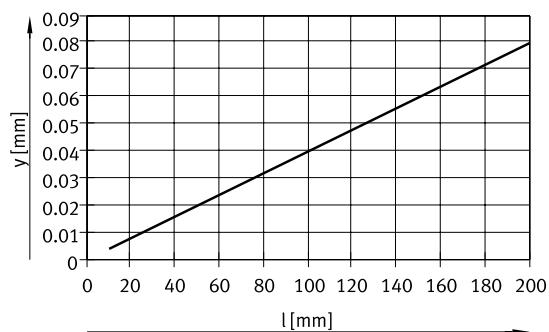
Linear travel accuracy y as a function of stroke length l 

Data sheet

Adjustable end-position range

Coarse adjustment of the advanced end position

With the mini slide DGSL, the advanced fixed stop can be relocated by swapping it with the cover.

This permits a stroke reduction down to the next but one smaller standard stroke through a combination of coarse and precision adjustments.

Advantages:

- Can be flexibly adapted to the application
- Integrated, which means reduced conversion effort and costs
- Large setting range

 **Note**
Removal of the fixed stops can severely damage the mini slide DGSL.

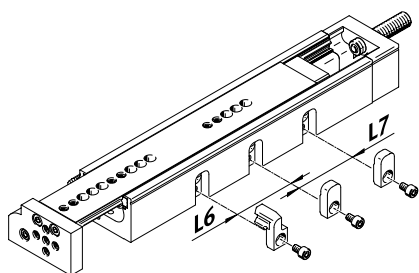

Size Stroke [mm]	4		6		8		10		12		16		20		25	
	L6	L7	L6	L7	L6	L7	L6	L7	L6	L7	L6	L7	L6	L7	L6	L7
10	-	-	-	-	-	-	-	-	-	-	-	-	-	-	-	-
20	10	-	14	-	10	-	-	-	-	-	-	-	-	-	-	-
30	10	-	14	-	16	-	-	-	-	-	-	-	-	-	-	-
40	-	-	14	-	16	-	-	-	-	-	-	-	-	-	-	-
50	-	-	14	14	16	-	-	-	-	-	-	-	-	-	-	-
80	-	-	-	-	16	16	24	-	29	-	35	-	-	-	55	-
100	-	-	-	-	-	-	24	24	29	-	35	-	44	-	55	-
150	-	-	-	-	-	-	-	-	29	29	35	-	44	-	55	-
200	-	-	-	-	-	-	-	-	-	-	-	-	44	44	55	-

Example:

DGSL-12-150-...

Max. stroke = 150 mm

By relocating the fixed stop by dimension L6:

$$\text{Stroke} = 150 - 29 = 121 \text{ mm}$$

By relocating the fixed stop by dimension L6 and L7:

$$\text{Stroke} = 150 - 29 - 29 = 92 \text{ mm}$$

The stroke can also be reduced through a precision adjustment:

$$\begin{aligned} \text{Stroke} &= 150 - 29 - 29 - 29 \\ &= 63 \text{ mm} \end{aligned}$$

Precision adjustment of the advanced and retracted end position

→ page 11

Data sheet

Adjustable end-position range

Precision adjustment of the advanced and retracted end position

Precision adjustment of the required stroke reduction is possible using the cushioning components (on the slide and in the end cap).

Advantages:

- Precision adjustment is accurately fixed by the clamping component
- No readjustment required, position is fully retained under lock and load

- Quick and easy adjustment, only one tool required

Step 1:
Loosen the clamping component

Step 2:
Position the slide by hand in the required end position

Step 3:
Turn the stop element with an Allen key until the end position is reached.

Step 4:
Tighten the clamping component

Step 1

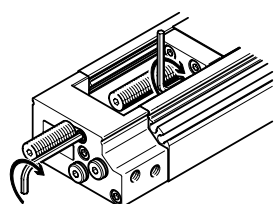

Step 2 ... 4

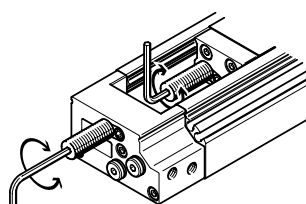

Adjustable end-position range [mm] per end position/stroke reduction

Size		4	6	8	10	12	16	20	25
Front end position									
With cushioning	P	-14.5	-16.5	-19.5	-27.5	-29	-37.5	-50.5	-55
	E	-4.5	-5	-4.5	-13	-9	-3.5	-6.5	-11.5
	P1	-14.5	-16.5	-19.5	-27.5	-29	-37.5	-50.5	-55
	Y3	-	-	-15	-24	-29	-36.5	-44	-56
	1)	-	-	-	-24	-29	-36.5	-44	-56
Rear end position									
With cushioning	P	-13.5	-15	-18.5	-20	-25.5	-39.5	-49.5	-49
	E	-3.5	-3.5	-3.5	-5.5	-5.5	-5.5	-5.5	-5.5
	P1	-13.5	-15	-18.5	-20	-25.5	-39.5	-49.5	-49
	Y3	-	-	-14	-15	-25.5	-38.5	-42	-51.5
	1)	-	-	-	-15	-25.5	-38.5	-42	-51.5

1) With reducing sleeve and next smaller shock absorber.

Note
The distance L of the cushioning component (→ operating instructions) are not permitted to fall below (factory setting).

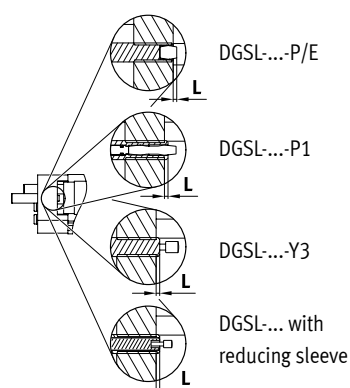

Note
The setting range of the advanced and retracted end position is restricted when using the cushioning type "E".

Data sheet

Shock absorber selection

Payload load m as a function of impact velocity v

With the mini slide DGSL, shock absorbers can be replaced and the cushioning behaviour can thus be influenced (depending on the payload).

This is done by removing the existing shock absorbers on the DGSL and replacing them with a smaller shock absorber as appropriate to the application.
(→ description below)

Graphs for selecting a suitable shock absorber as a function of the mounting position of the mini slide
→ from page 13

Ordering data
Shock absorbers DYSW, DYEY and reducing sleeve DAYH
→ Page 51

For smaller loads:

The next smaller shock absorber DYSW can be installed with the help of the reducing sleeve DAYH.

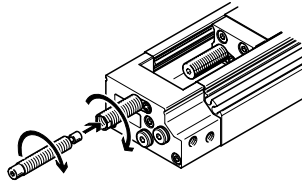
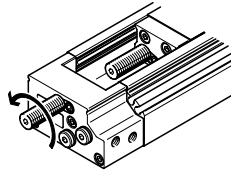

For very small loads:

The shock absorber DYEY can be installed.

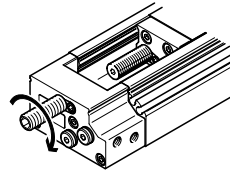
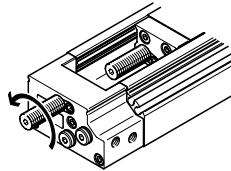

Selection example:

Current drive:

Mini slide: DGSL-10-...-Y3-A

Assuming:

Payload: 500 g

Impact velocity: 0.4 m/s

Mounting position: horizontal

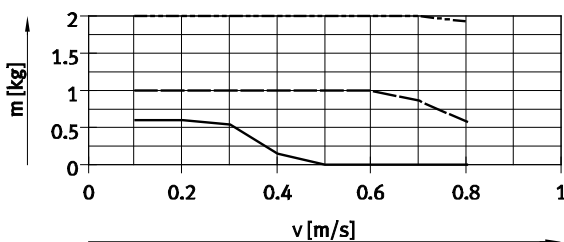

- DYSW-5-8 (cushioning Y3)
- DYSW-4-6 with DAYH-4 (cushioning Y11)
- DYEY-M8-Y1F

Result:

The first cushioning curve, which is located above the point of intersection, is the most suitable for this case.

Due to the low payload of less than one kilogram, the cushioning characteristics are greatly improved by replacing the shock absorber DYSW-5-8 integrated in the mini slide with the reducing sleeve DAYH-4 and the next smaller shock absorber DYSW-4-6.

Fundamentally, shock absorbers must be loaded.

Since the shock absorber DYSW-4-6 is more fully utilised in this case, both the service life of the shock absorber and the cushioning characteristics are improved.

Data sheet

Shock absorber selection

Payload m as a function of impact velocity v – horizontal mounting position

DGSL-4

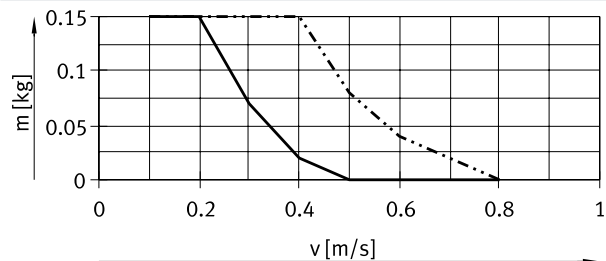

- DYEF-M4-Y1F (cushioning P1)
- · - · - DYEF-M4-Y1 (cushioning P)

DGSL-6

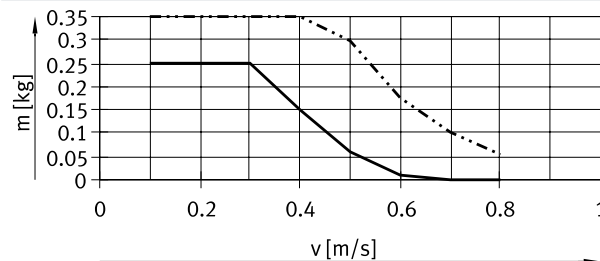

- DYEF-M5-Y1F (cushioning P1)
- · - · - DYEF-M5-Y1 (cushioning P)

DGSL-8

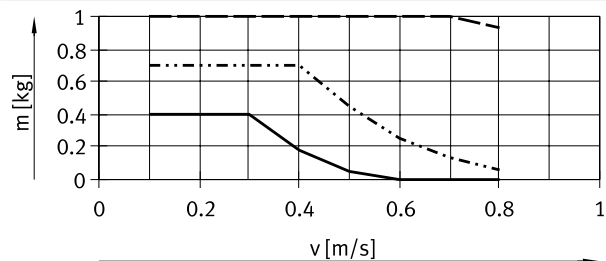

- DYEF-M6-Y1F (cushioning P1)
- · - · - DYEF-M6-Y1 (cushioning P)
- - - DYSW-4-6 (cushioning Y3)

DGSL-10

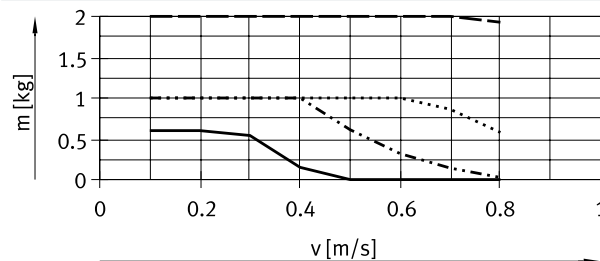

- DYEF-M8-Y1F (cushioning P1)
- · - · - DYEF-M8-Y1 (cushioning P)
- - - DYSW-5-8 (cushioning Y3)
- · · · · DYSW-4-6 with DAYH-4 (cushioning Y11)

DGSL-12

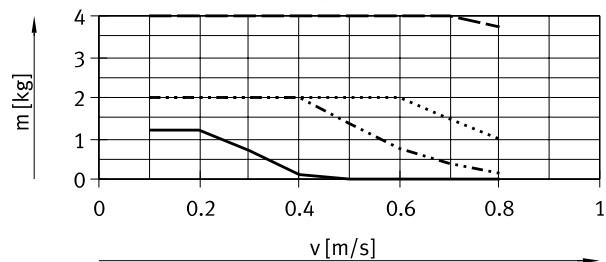

- DYEF-M10-Y1F (cushioning P1)
- · - · - DYEF-M10-Y1 (cushioning P)
- - - DYSW-7-10 (cushioning Y3)
- · · · · DYSW-5-8 with DAYH-5 (cushioning Y11)

DGSL-16

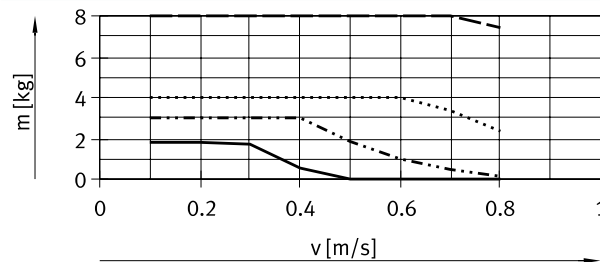

- DYEF-M12-Y1F (cushioning P1)
- · - · - DYEF-M12-Y1 (cushioning P)
- - - DYSW-8-14 (cushioning Y3)
- · · · · DYSW-7-10 with DAYH-7 (cushioning Y11)

DGSL-20

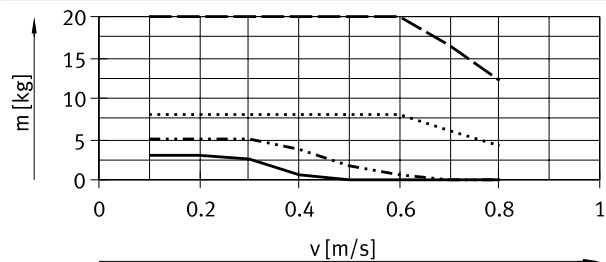

- DYEF-M14-Y1F (cushioning P1)
- · - · - DYEF-M14-Y1 (cushioning P)
- - - DYSW-10-17 (cushioning Y3)
- · · · · DYSW-8-14 with DAYH-8 (cushioning Y11)

DGSL-25

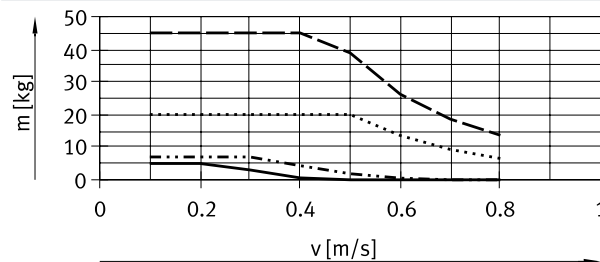

- DYEF-M16-Y1F (cushioning P1)
- · - · - DYEF-M16-Y1 (cushioning P)
- - - DYSW-12-20 (cushioning Y3)
- · · · · DYSW-10-17 with DAYH-10 (cushioning Y11)

Data sheet

Shock absorber selection

Payload m as a function of impact velocity v – vertical mounting position, payload moving upwards

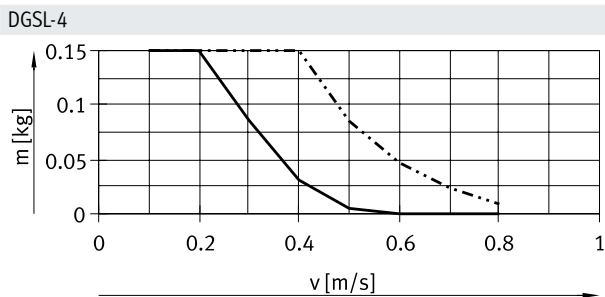

- DYEF-M4-Y1F (cushioning P1)
- DYEF-M4-Y1 (cushioning P)

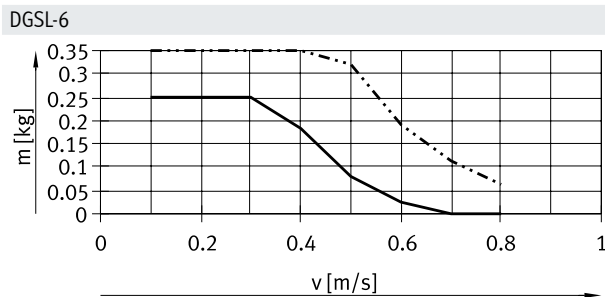

- DYEF-M5-Y1F (cushioning P1)
- DYEF-M5-Y1 (cushioning P)

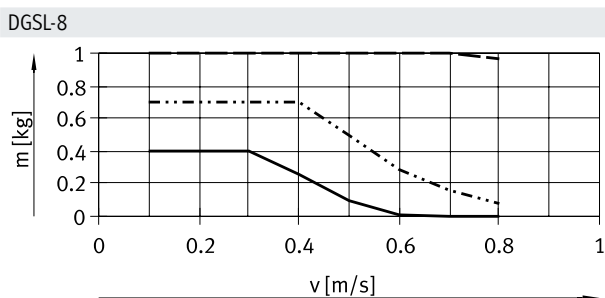

- DYEF-M6-Y1F (cushioning P1)
- DYEF-M6-Y1 (cushioning P)
- . - . - DYSW-4-6 (cushioning Y3)

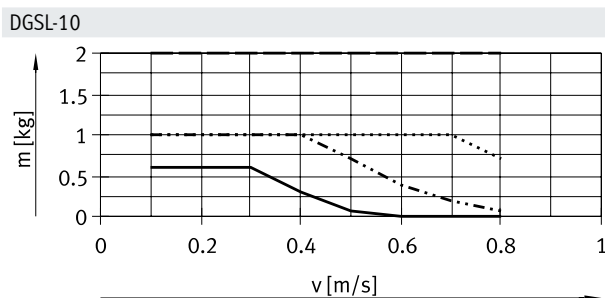

- DYEF-M8-Y1F (cushioning P1)
- DYEF-M8-Y1 (cushioning P)
- . - . - DYSW-5-8 (cushioning Y3)
- DYSW-4-6 with DAYH-4 (cushioning Y11)

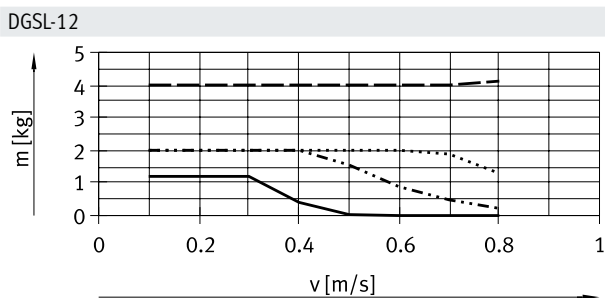

- DYEF-M10-Y1F (cushioning P1)
- DYEF-M10-Y1 (cushioning P)
- . - . - DYSW-7-10 (cushioning Y3)
- DYSW-5-8 with DAYH-5 (cushioning Y11)

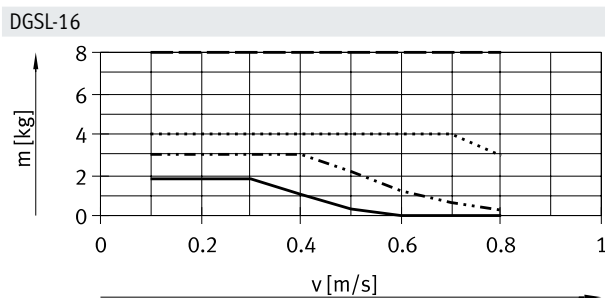

- DYEF-M12-Y1F (cushioning P1)
- DYEF-M12-Y1 (cushioning P)
- . - . - DYSW-8-14 (cushioning Y3)
- DYSW-7-10 with DAYH-7 (cushioning Y11)

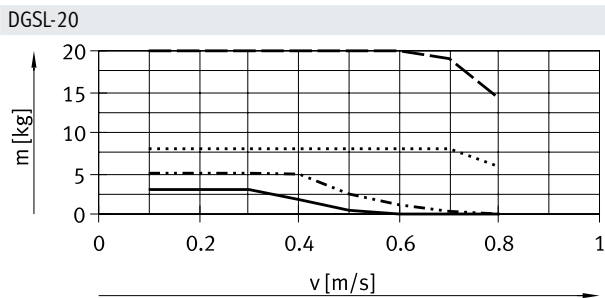

- DYEF-M14-Y1F (cushioning P1)
- DYEF-M14-Y1 (cushioning P)
- . - . - DYSW-10-17 (cushioning Y3)
- DYSW-8-14 with DAYH-8 (cushioning Y11)

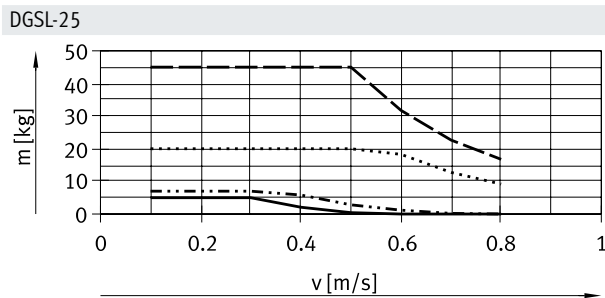

- DYEF-M16-Y1F (cushioning P1)
- DYEF-M16-Y1 (cushioning P)
- . - . - DYSW-12-20 (cushioning Y3)
- DYSW-10-17 with DAYH-10 (cushioning Y11)

Data sheet

Shock absorber selection

Payload m as a function of impact velocity v – vertical mounting position, payload moving downwards

DGSL-4

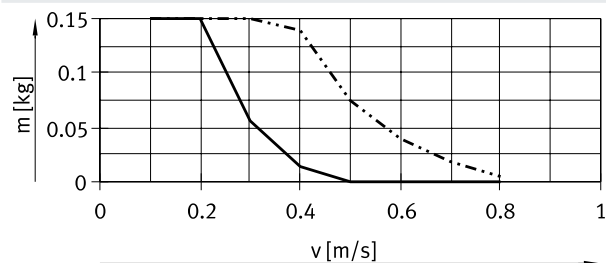

- DYEF-M4-Y1F (cushioning P1)
- · · · · · DYEF-M4-Y1 (cushioning P)

DGSL-6

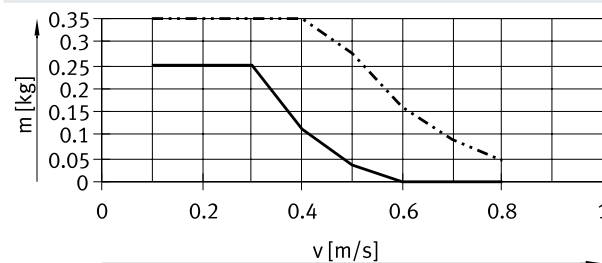

- DYEF-M5-Y1F (cushioning P1)
- · · · · · DYEF-M5-Y1 (cushioning P)

DGSL-8

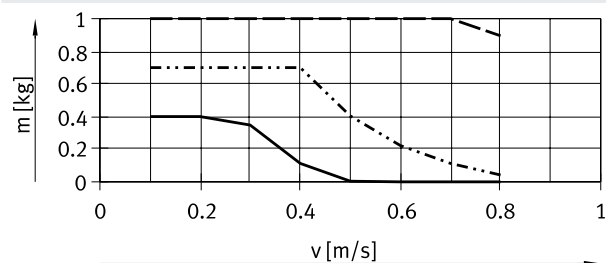

- DYEF-M6-Y1F (cushioning P1)
- · · · · · DYEF-M6-Y1 (cushioning P)
- - - - - DYSW-4-6 (cushioning Y3)

DGSL-10

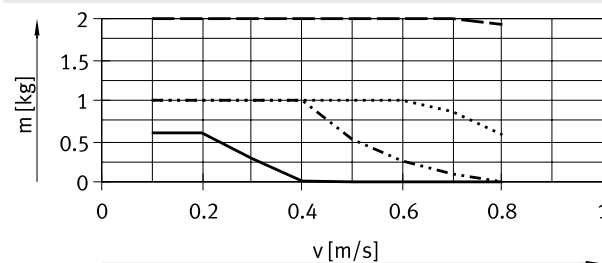

- DYEF-M8-Y1F (cushioning P1)
- · · · · · DYEF-M8-Y1 (cushioning P)
- - - - - DYSW-5-8 (cushioning Y3)
- · · · · DYSW-4-6 with DAYH-4 (cushioning Y11)

DGSL-12

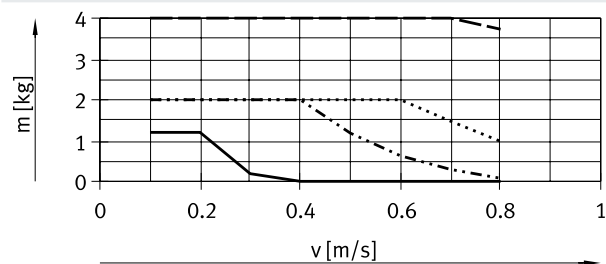

- DYEF-M10-Y1F (cushioning P1)
- · · · · · DYEF-M10-Y1 (cushioning P)
- - - - - DYSW-7-10 (cushioning Y3)
- · · · · DYSW-5-8 with DAYH-5 (cushioning Y11)

DGSL-16

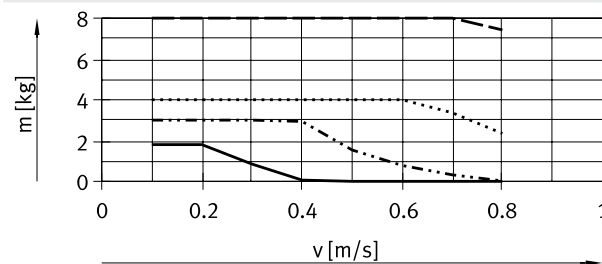

- DYEF-M12-Y1F (cushioning P1)
- · · · · · DYEF-M12-Y1 (cushioning P)
- - - - - DYSW-8-14 (cushioning Y3)
- · · · · DYSW-7-10 with DAYH-7 (cushioning Y11)

DGSL-20

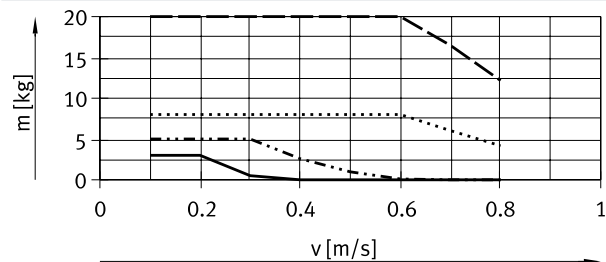

- DYEF-M14-Y1F (cushioning P1)
- · · · · · DYEF-M14-Y1 (cushioning P)
- - - - - DYSW-10-17 (cushioning Y3)
- · · · · DYSW-8-14 with DAYH-8 (cushioning Y11)

DGSL-25

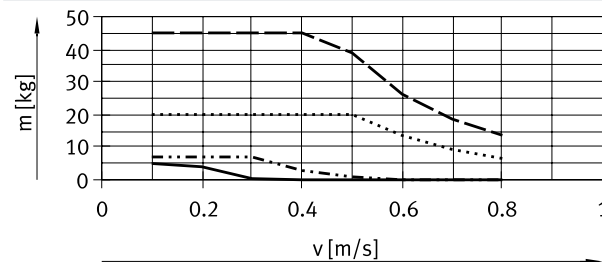

- DYEF-M16-Y1F (cushioning P1)
- · · · · · DYEF-M16-Y1 (cushioning P)
- - - - - DYSW-12-20 (cushioning Y3)
- · · · · DYSW-10-17 with DAYH-10 (cushioning Y11)

Data sheet

Shock absorber selection

Travel time t as a function of payload m and cushioning P/E – horizontal mounting position

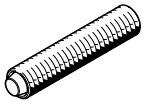

The values in the graphs are determined by calculation.
The travel time as a function of payload must not be reduced below the values shown, because the kinetic impact or residual energy in the end positions can result in damage to the drive.

Vertical mounting position
→ page 19

Advancing

Stroke 10 mm, size 4 ... 10

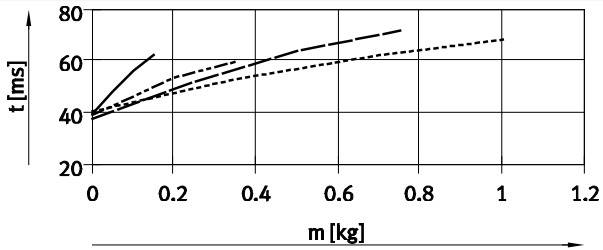

Retracting

Stroke 10 mm, size 4 ... 10

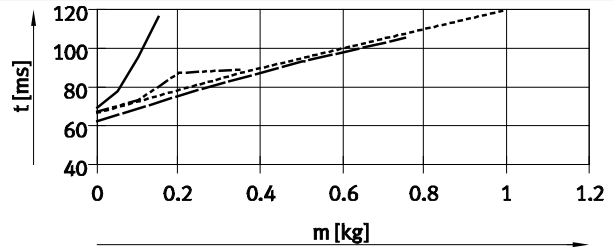

Stroke 10 mm, size 12 ... 16

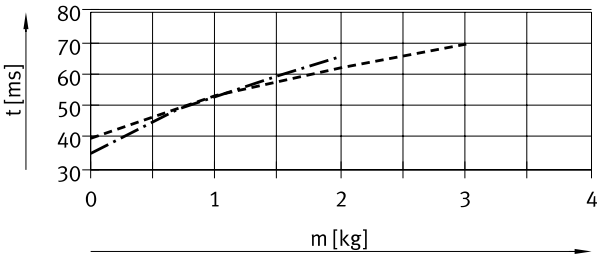

Stroke 10 mm, size 12 ... 16

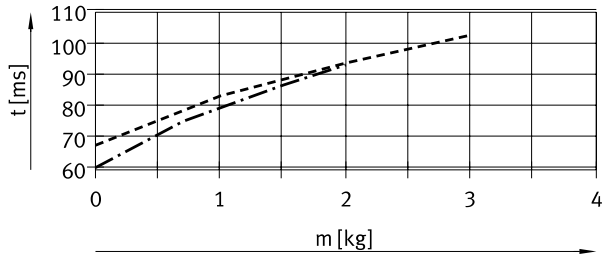

Stroke 10 mm, size 20 ... 25

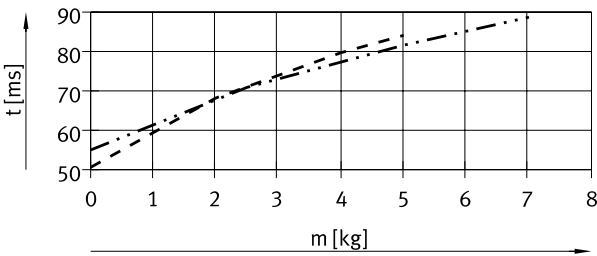

Stroke 10 mm, size 20 ... 25

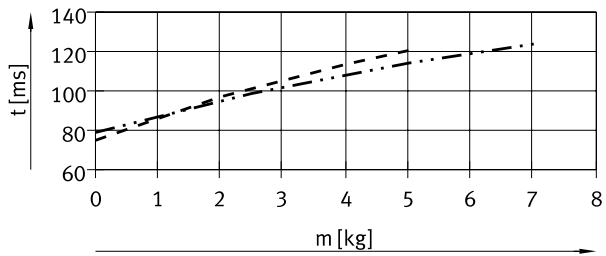

Stroke 30 mm, size 4 ... 10

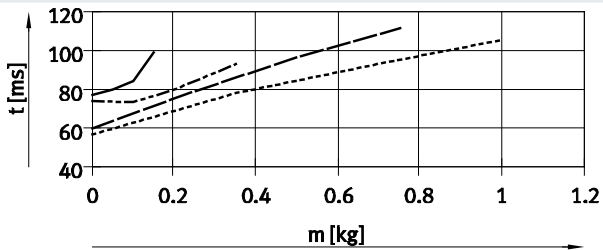

Stroke 30 mm, size 4 ... 10

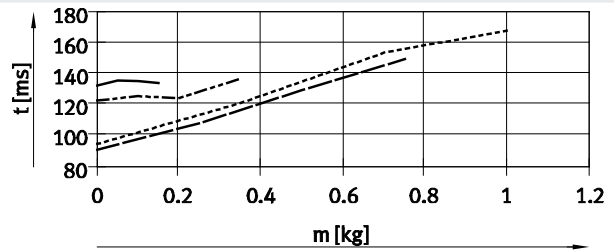

- | | |
|---------------------|---------------------|
| ————— DGSL-4 | - . - . - . DGSL-12 |
| - DGSL-6 | - - - - - DGSL-16 |
| - - - - - DGSL-8 | - - - - - DGSL-20 |
| - DGSL-10 | - . . . - DGSL-25 |

Data sheet

Shock absorber selection

Travel time t as a function of payload m and cushioning P/E – horizontal mounting position



The values in the graphs are determined by calculation.

The travel time as a function of payload must not be reduced below the values shown, because the kinetic impact or residual energy in the end positions can result in damage to the drive.

Vertical mounting position

→ page 19

Advancing

Stroke 30 mm, size 12 ... 25

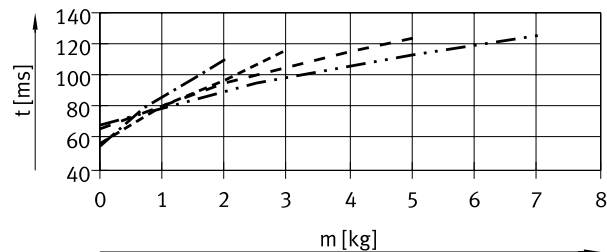

Retracting

Stroke 30 mm, size 12 ... 16

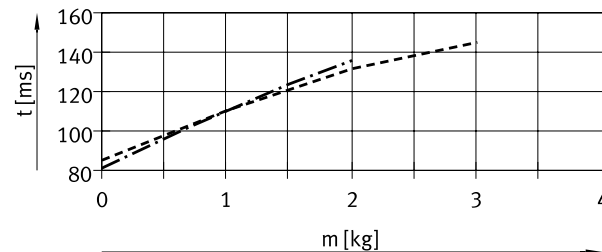

Stroke 30 mm, size 20 ... 25

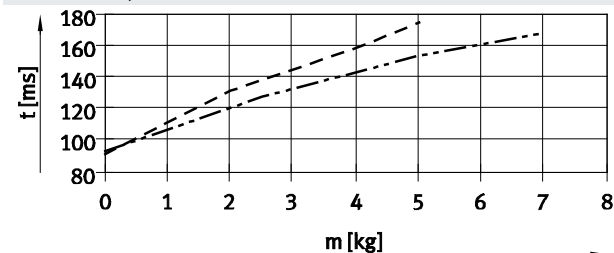

Stroke 50 mm, size 6 ... 12

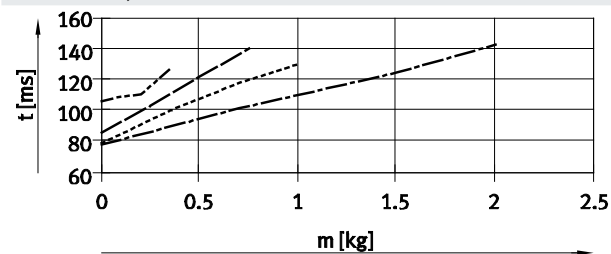

Stroke 50 mm, size 6 ... 12

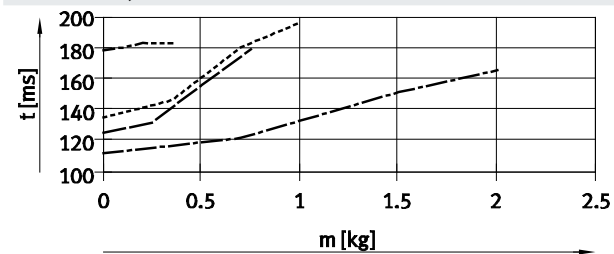

Stroke 50 mm, size 16 ... 25

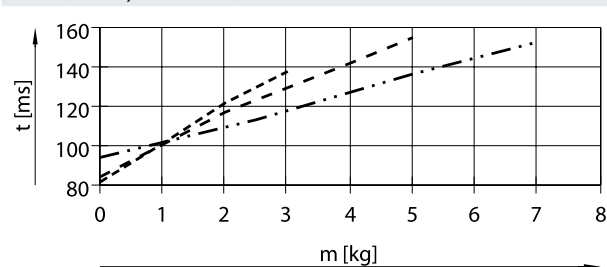

Stroke 50 mm, size 16

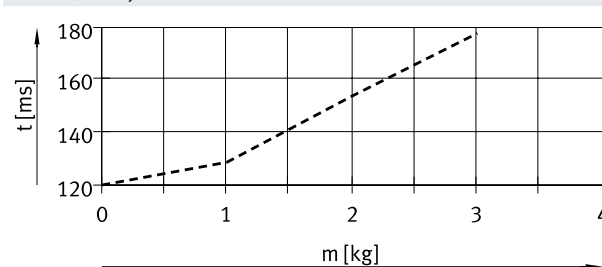

Stroke 50 mm, size 20 ... 25

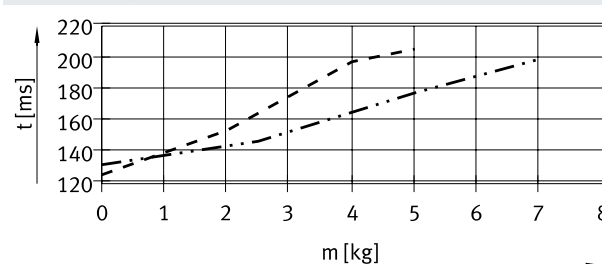

Data sheet

Shock absorber selection

Travel time t as a function of payload m and cushioning P/E – horizontal mounting position

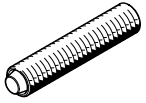

The values in the graphs are determined by calculation.
The travel time as a function of payload must not be reduced below the values shown, because the kinetic impact or residual energy in the end positions can result in damage to the drive.

Vertical mounting position
→ page 19

Advancing

Stroke 100 mm, size 10 ... 16

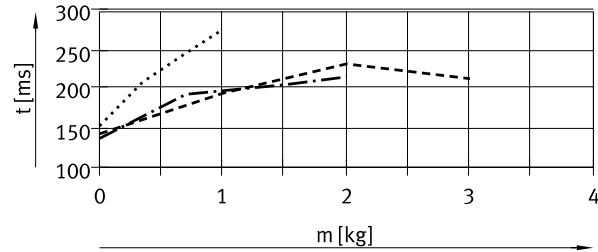

Retracting

Stroke 100 mm, size 10 ... 16

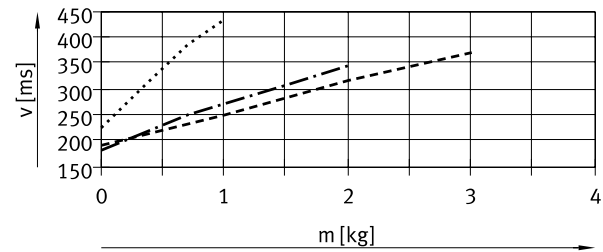

Stroke 100 mm, size 20 ... 25

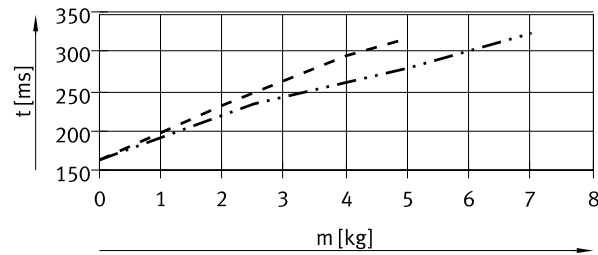

Stroke 100 mm, size 20 ... 25

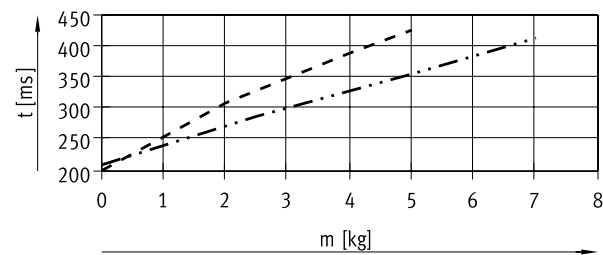

Stroke 150 mm, size 12 ... 16

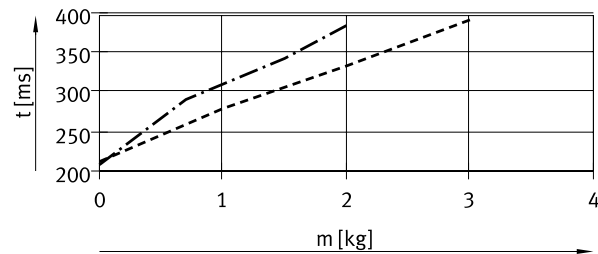

Stroke 150 mm, size 12 ... 16

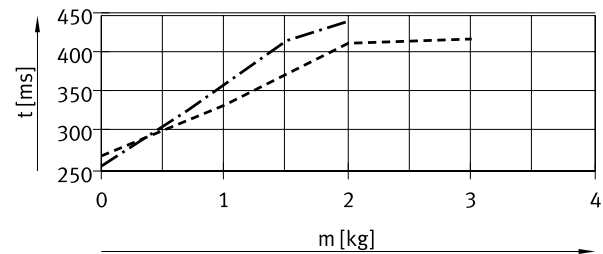

Stroke 150 mm, size 20 ... 25

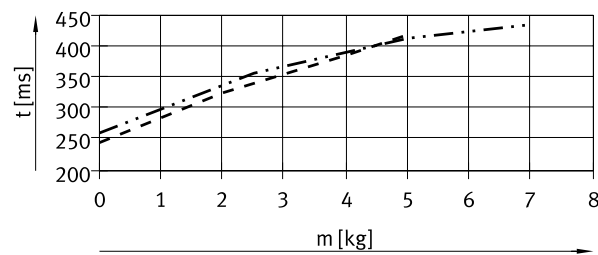

Stroke 150 mm, size 20 ... 25

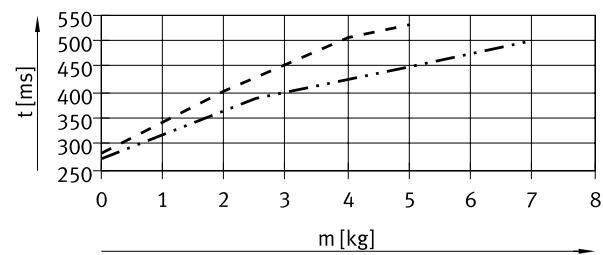

- DGSL-10
- . - . - DGSL-12
- - - - - DGSL-16
- - - - - DGSL-20
- . - . - DGSL-25

Data sheet

Shock absorber selection

Travel time t as a function of payload m and cushioning P/E – horizontal mounting position

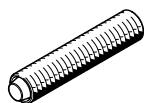

The values in the graphs are determined by calculation.
The travel time as a function of payload must not be reduced below the values shown, because the kinetic impact or residual energy in the end positions can result in damage to the drive.

Vertical mounting position
→ page 19

Advancing

Stroke 200 mm, size 20 ... 25

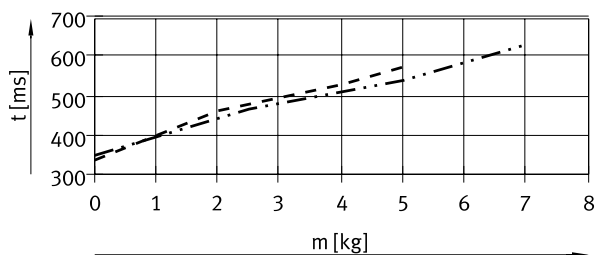

Retracting

Stroke 200 mm, size 20 ... 25

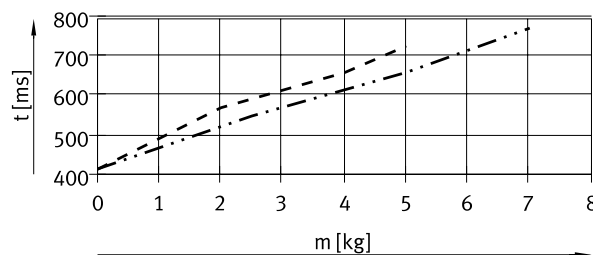

--- DGSL-20
- . - DGSL-25

Vertical mounting position

The travel times for a vertical mounting position are calculated by multiplying the data for a horizontal mounting position by a correction factor k_a (advancing) and k_r (retracting), see adjacent table.

Assuming:
Stroke = 200 mm
Size = 20
Payload = 3 kg
Calculated travel time t_h (horizontal),
see graph:

- Advancing = 500 ms
- Retracting = 600 ms

Calculated travel time t_v (vertical):

- Advancing: $t_v = t_h \times k_a$
 $t_s = 500 \text{ ms} \times 0.9 = 450 \text{ ms}$
- Retracting: $t_v = t_h \times k_r$
 $t_s = 600 \text{ ms} \times 1.1 = 660 \text{ ms}$

Stroke [mm]	Size	Advancing (k_a) ¹⁾	Retracting (k_r)
10	4, 6, 8, 10	0.95	1.1
	12, 16, 20, 25	0.95	1.2
30	4, 6, 8, 10	0.95	1.1
	12, 16, 20, 25	0.95	1.2
50	6, 8, 10, 12	0.9	1.1
	16, 20, 25	1.1	1.2
100	10, 12, 16, 20, 25	1	1.1
150	12, 16, 20, 25	1	1.1
200	20, 25	0.9	1.1

1) Downward.

Data sheet

Shock absorber selection

Travel time t as a function of payload m and cushioning P1 – horizontal mounting position



The values in the graphs are determined by calculation.
The travel time as a function of payload must not be reduced below the values shown, because the kinetic impact or residual energy in the end positions can result in damage to the drive.

Vertical mounting position
→ page 23

Advancing

Stroke 10 mm, size 4 ... 10

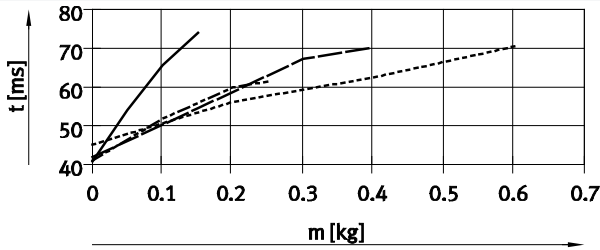

Retracting

Stroke 10 mm, size 4 ... 10

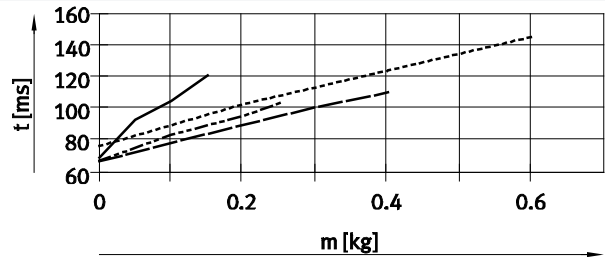

Stroke 10 mm, size 12 ... 16

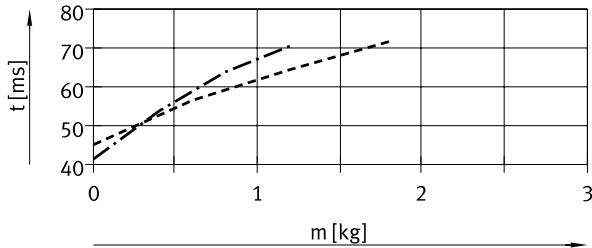

Stroke 10 mm, size 12 ... 16

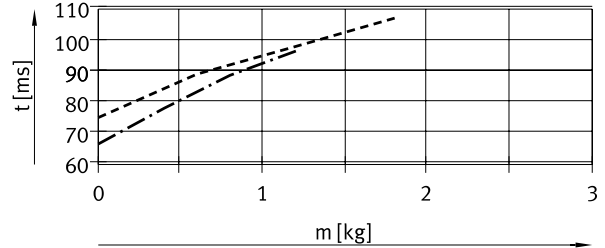

Stroke 10 mm, size 20 ... 25

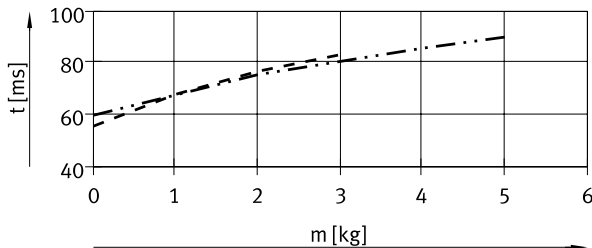

Stroke 10 mm, size 20 ... 25

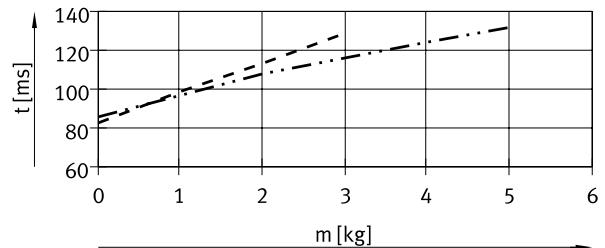

Stroke 30 mm, size 4 ... 10

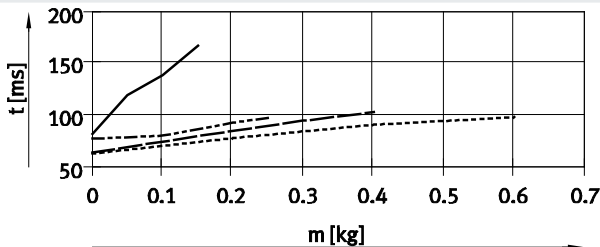

Stroke 30 mm, size 4 ... 10

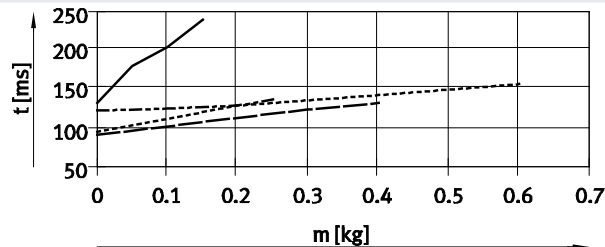

- DGSL-4
- DGSL-6
- — — DGSL-8
- DGSL-10
- · — · — DGSL-12
- — — — — DGSL-16
- — — — — DGSL-20
- · — · — DGSL-25

Data sheet

Shock absorber selection

Travel time t as a function of payload m and cushioning P1 – horizontal mounting position

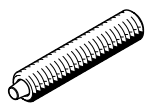

The values in the graphs are determined by calculation.
The travel time as a function of payload must not be reduced below the values shown, because the kinetic impact or residual energy in the end positions can result in damage to the drive.

Vertical mounting position
→ page 23

Advancing

Stroke 30 mm, size 12 ... 16

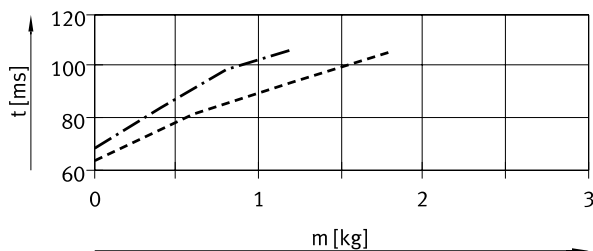

Retracting

Stroke 30 mm, size 12 ... 16

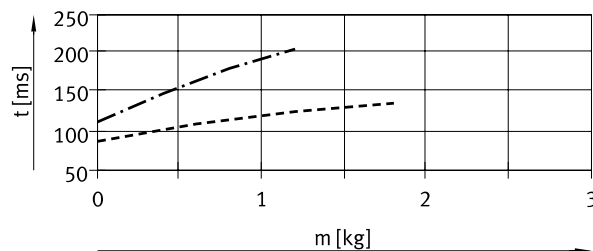

Stroke 30 mm, size 20 ... 25

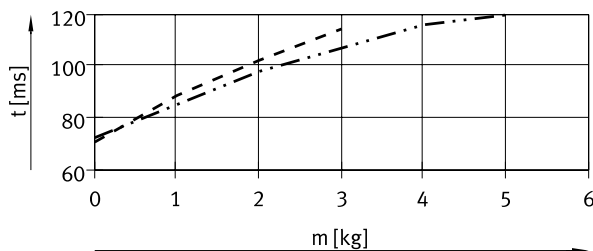

Stroke 30 mm, size 20 ... 25

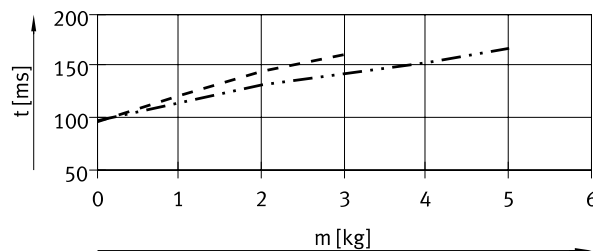

Stroke 50 mm, size 6 ... 12

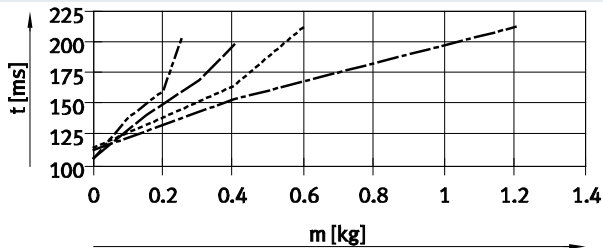

Stroke 50 mm, size 6 ... 12

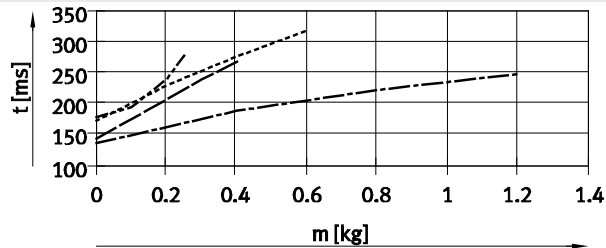

Stroke 50 mm, size 16 ... 25

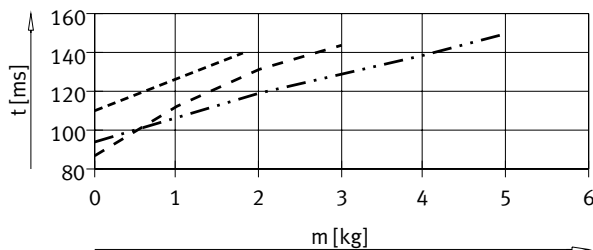

Stroke 50 mm, size 16 ... 25

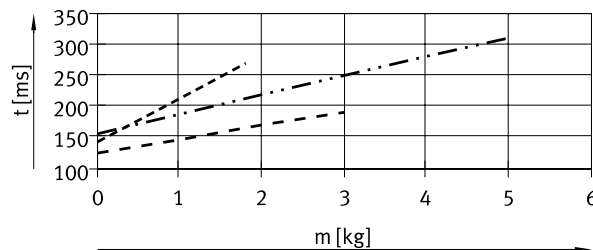

- DGSL-6
- DGSL-8
- DGSL-10
- DGSL-12
- DGSL-16
- DGSL-20
- DGSL-25

Data sheet

Shock absorber selection

Travel time t as a function of payload m and cushioning P1 – horizontal mounting position

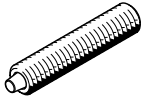

The values in the graphs are determined by calculation.
The travel time as a function of payload must not be reduced below the values shown, because the kinetic impact or residual energy in the end positions can result in damage to the drive.

Vertical mounting position
→ page 23

Advancing

Stroke 100 mm, size 10 ... 16

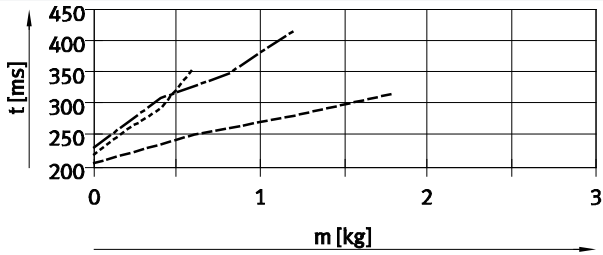

Retracting

Stroke 100 mm, size 10 ... 25

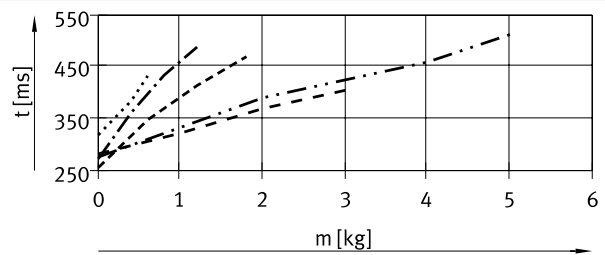

Stroke 100 mm, size 20 ... 25

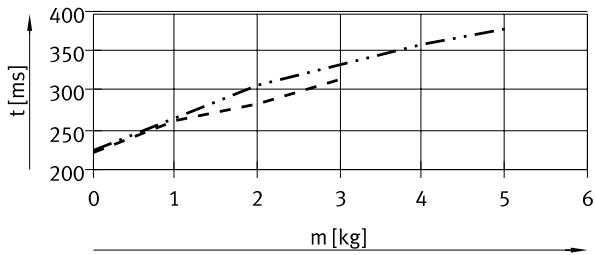

Stroke 150 mm, size 12 ... 25

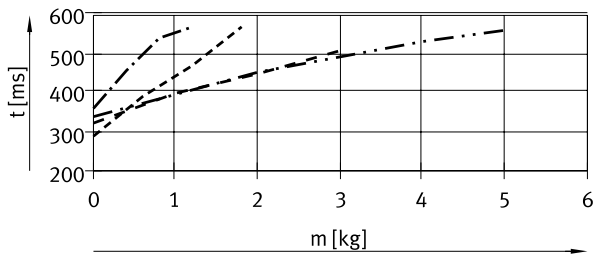

Stroke 150 mm, size 12 ... 25

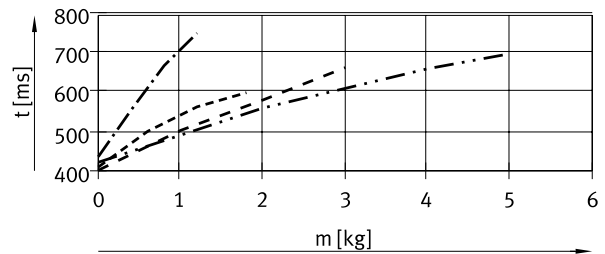

- DGSL-10
- · - · - DGSL-12
- - - - - DGSL-16
- - - - - DGSL-20
- · - · - DGSL-25

Data sheet

Shock absorber selection

Travel time t as a function of payload m and cushioning P1 – horizontal mounting position

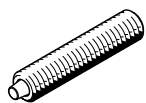

The values in the graphs are determined by calculation.
The travel time as a function of payload must not be reduced below the values shown, because the kinetic impact or residual energy in the end positions can result in damage to the drive.

Vertical mounting position
→ page 23

Advancing

Stroke 200 mm, size 20

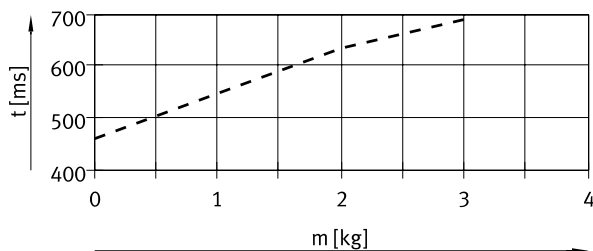

Retracting

Stroke 200 mm, size 20

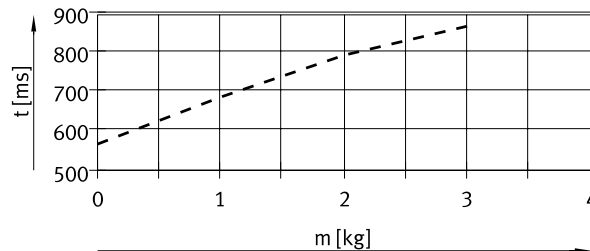

Stroke 200 mm, size 25

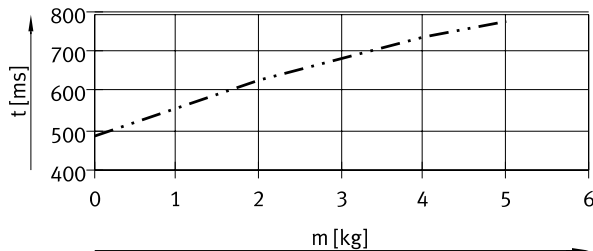

Stroke 200 mm, size 25

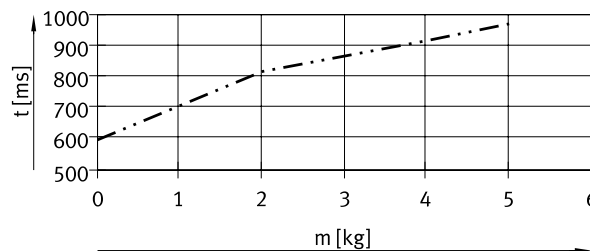

--- DGSL-20
- . - DGSL-25

Vertical mounting position

The travel times for a vertical mounting position are calculated by multiplying the data for a horizontal mounting position by a correction factor k_a (advancing) and k_r (retracting), see adjacent table.

Assuming:
Stroke = 200 mm
Size = 20
Payload = 2 kg
Calculated travel time t_h (horizontal), see graph:
– Advancing = 640 ms
– Retracting = 780 ms
Calculated travel time t_v (vertical):
– Advancing: $t_v = t_h \times k_a$
 $t_s = 640 \text{ ms} \times 0.9 = 576 \text{ ms}$
– Retracting: $t_v = t_h \times k_r$
 $t_s = 780 \text{ ms} \times 1.1 = 858 \text{ ms}$

Stroke [mm]	Size	Advancing (k_a) ¹⁾	Retracting (k_r)
10	4, 6, 8, 10	1	1.1
	12, 16, 20, 25	1.1	1.2
30	4, 6, 8, 10	1	1.1
	12, 16, 20, 25	1.1	1.2
50	6, 8, 10, 12	1	1.1
	16, 20, 25	0.9	1.1
100	10, 12, 16, 20, 25	0.95	1.1
150	12, 16, 20, 25	0.95	1.1
200	20, 25	0.9	1.1

1) Downward.

Data sheet

Shock absorber selection

Travel time t as a function of payload m and cushioning Y3 – horizontal mounting position

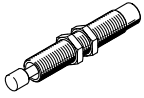

The values in the graphs are determined by calculation.
The travel time as a function of payload must not be reduced below the values shown, because the kinetic impact or residual energy in the end positions can result in damage to the drive.

Vertical mounting position
→ page 25

Advancing

Stroke 30 mm, size 8 ... 12

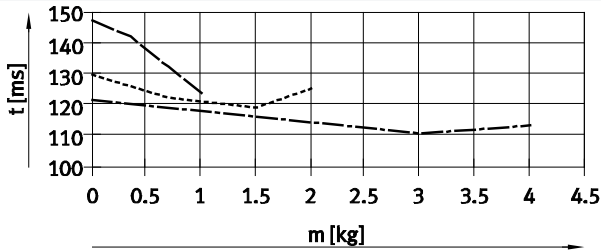

Retracting

Stroke 30 mm, size 8 ... 12

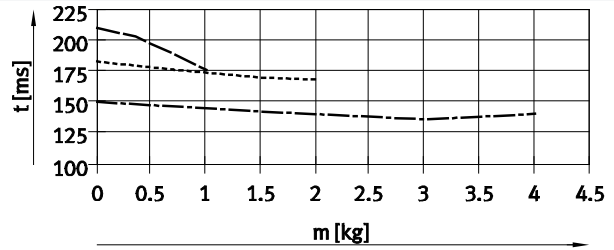

Stroke 30 mm, size 16 ... 25

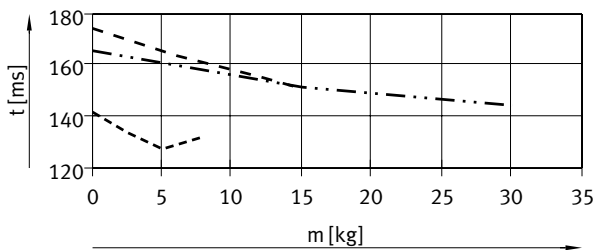

Stroke 30 mm, size 16 ... 25

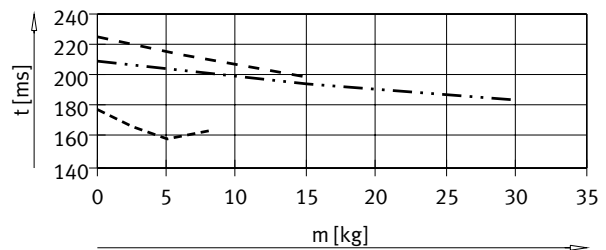

Stroke 50 mm, size 8 ... 12

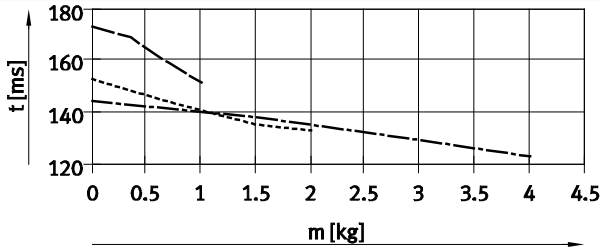

Stroke 50 mm, size 8 ... 12

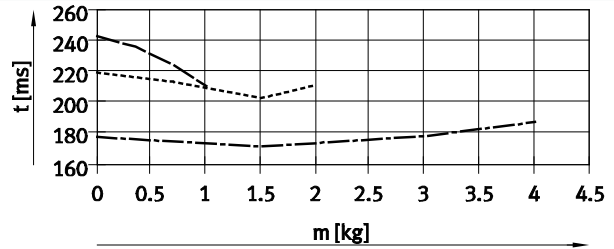

Stroke 50 mm, size 16 ... 25

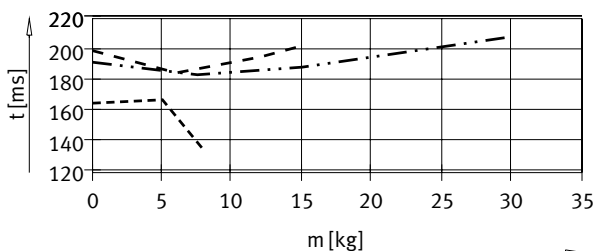

Stroke 50 mm, size 16 ... 25

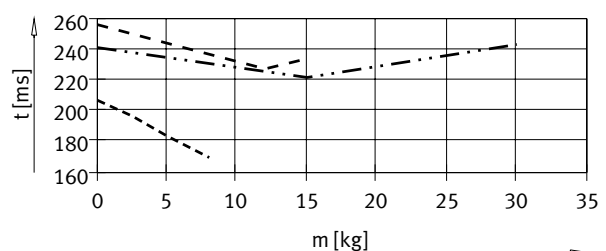

- DGSL-10
- · - · - DGSL-12
- - - - - DGSL-16
- - - - - DGSL-20
- · - · - DGSL-25

Data sheet

Shock absorber selection

Travel time t as a function of payload m and cushioning Y3 – horizontal mounting position

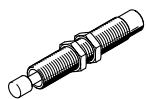

The values in the graphs are determined by calculation.
The travel time as a function of payload must not be reduced below the values shown, because the kinetic impact or residual energy in the end positions can result in damage to the drive.

Vertical mounting position
→ page 25

Advancing

Stroke 100 mm, size 10 ... 25

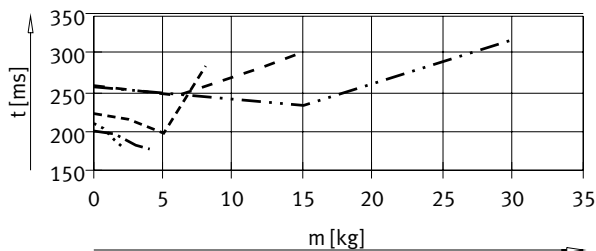

Retracting

Stroke 100 mm, size 10 ... 25

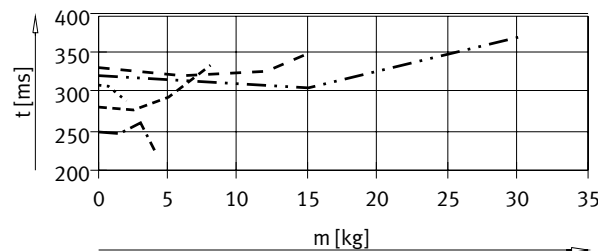

Stroke 150 mm, size 12 ... 25

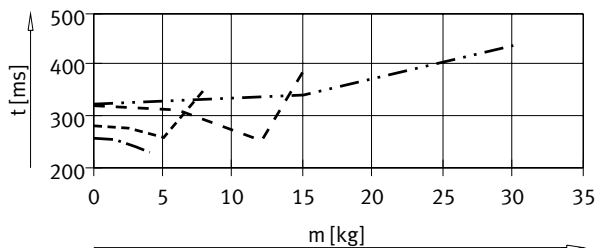

Stroke 150 mm, size 12 ... 25

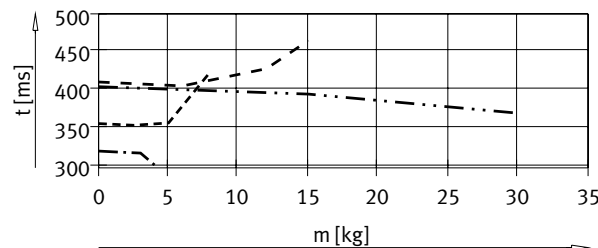

Stroke 200 mm, size 20 ... 25

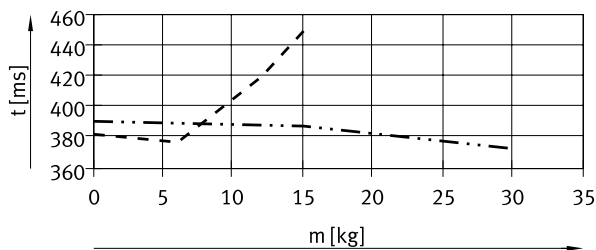

Stroke 200 mm, size 20 ... 25

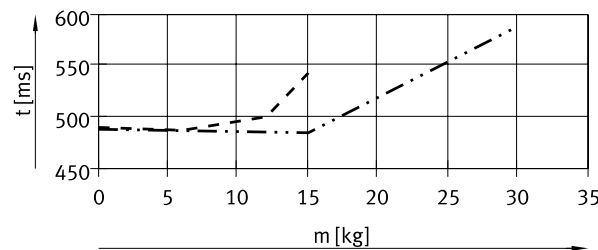

--- DGSL-20
-.- DGSL-25

Vertical mounting position

The travel times for a vertical mounting position are calculated by multiplying the data for a horizontal mounting position by a correction factor k_a (advancing) and k_r (retracting), see adjacent table.

Assuming:
Stroke = 200 mm
Size = 20
Payload = 10 kg
Calculated travel time t_h (horizontal), see graph:
– Advancing = 405 ms
– Retracting = 490 ms
Calculated travel time t_v (vertical):
– Advancing: $t_v = t_h \times k_a$
 $t_s = 405 \text{ ms} \times 0.9 = 365 \text{ ms}$
– Retracting: $t_v = t_h \times k_r$
 $t_s = 490 \text{ ms} \times 1.5 = 735 \text{ ms}$

Stroke [mm]	Size	Advancing (k_a) ¹⁾	Retracting (k_r)
30	8, 10, 12	0.95	1.2
	16, 20, 25	0.9	1.5
50	8, 10, 12	0.9	1.5
	16, 20, 25	0.9	1.5
100	10, 12, 16, 20, 25	0.8	1.5
150	12, 16, 20, 25	0.9	1.5
200	20, 25	0.9	1.5

1) Downward.

Data sheet

Dynamic characteristic load values

The indicated torques refer to the centre of the guide.
 These values must not be exceeded during dynamic operation. Special attention must be paid to the deceleration phase.

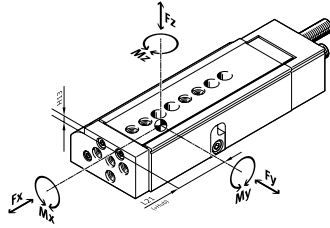

If the drive is simultaneously subjected to several of the forces and torques indicated below, the following equation must be satisfied in addition to the indicated maximum loads:

$$\frac{F_y}{F_{y_{max}}} + \frac{F_z}{F_{z_{max}}} + \frac{M_x}{M_{x_{max}}} + \frac{M_y}{M_{y_{max}}} + \frac{M_z}{M_{z_{max}}} \leq 1$$

Position of the guide centre

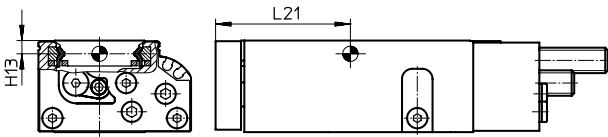

Calculation example

Assuming:

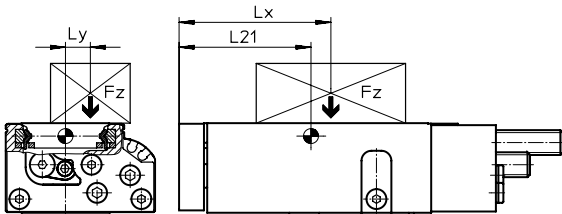

Mini slide = DGSL-10
 Stroke length = 80 mm
 Lever arm L_x = 50 mm
 Lever arm L_y = 30 mm
 Load F_z = 0.8 kg
 Acceleration a = 0 m/s²

Required:

F_y, F_z, M_x, M_y, M_z
 and
 Verification of operation with combined load

Solution:

$L_{21} = 83$ mm from table

$F_y = 0$ N

$F_z = m \times g$
 $= 0.8 \text{ kg} \times 9.81 \text{ m/s}^2 = 7.848$ N

$M_x = m \times g \times L_y$
 $= 0.8 \text{ kg} \times 9.81 \text{ m/s}^2 \times 30 \text{ mm} = 0.236$ Nm

$M_y = m \times g \times [(L_{21} + \text{Hub}) - L_x]$
 $= 0.8 \text{ kg} \times 9.81 \text{ m/s}^2 \times [(83 \text{ mm} + 80 \text{ mm}) - 50 \text{ mm}] = 0.886$ Nm

$M_z = 0$ Nm

Combined load:

$$\frac{F_y}{F_{y_{max}}} + \frac{F_z}{F_{z_{max}}} + \frac{M_x}{M_{x_{max}}} + \frac{M_y}{M_{y_{max}}} + \frac{M_z}{M_{z_{max}}} \leq 1$$

$$0 + \frac{7.848 \text{ N}}{1200 \text{ N}} + \frac{0.236 \text{ Nm}}{18 \text{ Nm}} + \frac{0.886 \text{ Nm}}{12 \text{ Nm}} + 0 \leq 1$$

Permissible forces and torques						Geometric characteristics	
Size	Stroke [mm]	$F_{y_{max}}$ [N]	$F_{z_{max}}$ [N]	$M_{x_{max}}$ [Nm]	$M_{y_{max}}, M_{z_{max}}$ [Nm]	H13 [mm]	L21 [mm]
4	10	343	343	2	2	2.7	31
	20	368	368	2	2		36
	30	387	387	2	2		42
6	10	540	540	6	4.5	3.4	37
	20	590	590	7	5		42
	30	631	631	8	5.5		47
	40	677	677	8	5.5		52
	50	719	719	8	5.5		57

Data sheet

Permissible forces and torques						Geometric characteristics	
Size	Stroke [mm]	F _y _{max} [N]	F _z _{max} [N]	M _x _{max} [Nm]	M _y _{max} , M _z _{max} [Nm]	H13 [mm]	L21 [mm]
8							
	10	657	657	7	5.5	3.25	41
	20	745	745	8	5.5		46
	30	850	850	9	5.5		51
	40	934	934	10	5.5		56
	50	962	962	10	8		67
	80	971	971	10	8		82
10							
	10	927	927	15	6	4.2	43
	20	1003	1003	15	7		46
	30	1078	1078	15	8		51
	40	1152	1152	15	9		56
	50	1175	1175	18	9		61
	80	1200	1200	18	12		83
	100	1250	1250	18	12		96
12							
	10	942	942	15	8	5.2	44
	20	1006	1006	15	9		49
	30	1075	1075	15	10		54
	40	1142	1142	18	11		59
	50	1200	1200	18	12		64
	80	1280	1280	20	15		88
	100	1340	1340	20	15		98
	150	1400	1400	20	15		124
16							
	10	1769	1769	35	20	6.4	54
	20	2021	2021	35	22		59
	30	2274	2274	35	22		64
	40	2527	2527	40	25		69
	50	2780	2780	40	25		74
	80	2800	2800	50	27		89
	100	2850	2850	50	43		113
	150	2900	2900	50	43		138
20							
	10	2911	2911	60	30	7.55	56
	20	3143	3143	60	30		61
	30	3354	3354	60	30		66
	40	3612	3612	60	40		71
	50	3816	3816	70	50		76
	80	4032	4032	80	50		91
	100	4200	4200	85	80		121
	150	4400	4400	90	80		152
	200	4600	4600	90	80		177
25							
	10	3270	3270	100	60	8.55	64
	20	3744	3744	100	60		69
	30	4205	4205	100	60		74
	40	4643	4643	110	60		79
	50	4650	4650	120	60		84
	80	4700	4700	130	80		112
	100	4750	4750	130	80		129
	150	4800	4800	130	80		154
	200	4800	4800	130	80		179

Data sheet

Dimensions

Size 4 ... 10

Download CAD data → www.festo.com

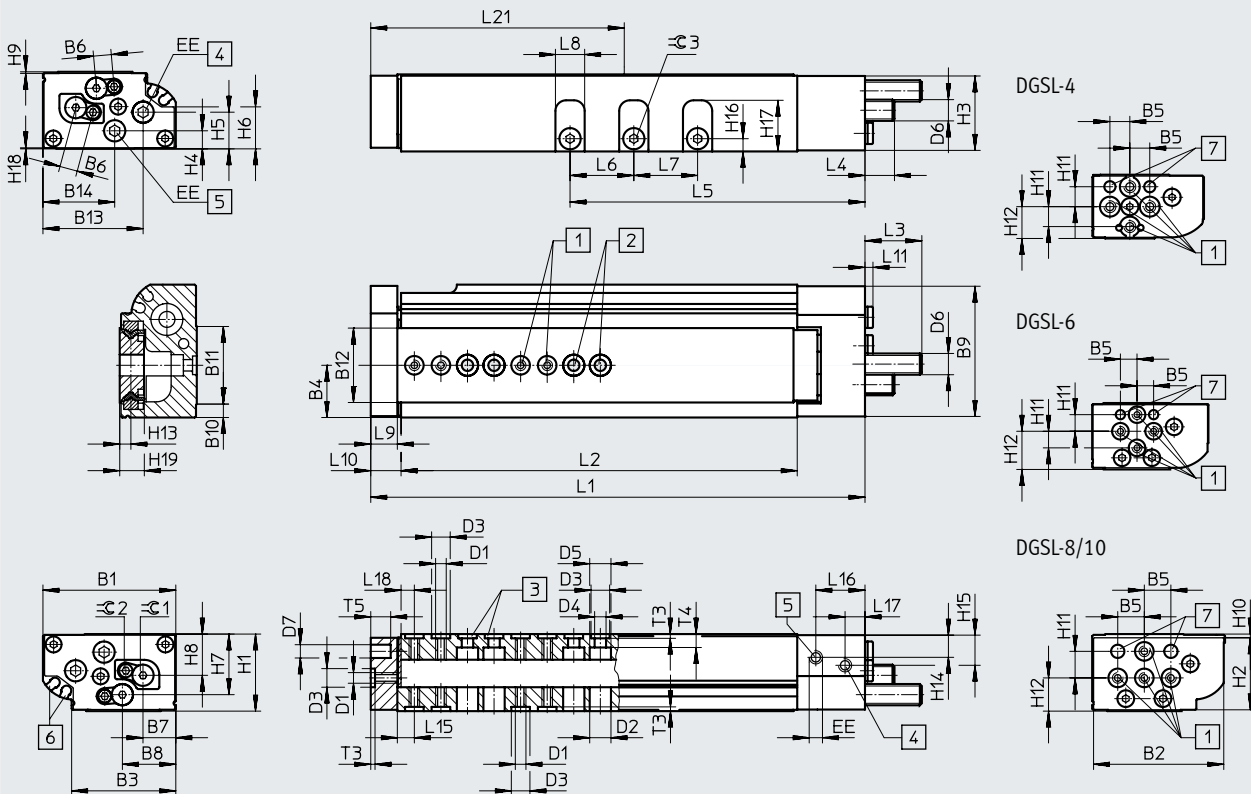

- [1] Mounting thread (centring sleeves included in the scope of delivery)
- [2] Through-holes for mounting the drive
- [3] Centring holes (centring sleeves included in the scope of delivery)
- [4] Supply port, advancing
- [5] Supply port, retracting
- [6] Sensor slots for proximity switch SME/SMT-10
- [7] Centring hole
- L10 Distance between outer edge of yoke plate and housing
- L15 Distance between centre of centring hole and outer edge of slide
- L18 Distance between centre of centring hole and outer edge of housing

General dimensions

Size	B1	B2	B3	B4	B5	B6	B7	B8	B9	B10	B11	B12	B13	B14	D1
4	28	27.4	18.35	9.4	5	3.55	6.3	11.95	27.5	2	17.2	12.4	23.15	16.15	M3
6	35	34.5	26.3	13.5	5	5	8.2	13.55	34.5	3.5	19.9	20	28.1	18.9	M3
8	42	41.3	31.45	16.6	10	6	10.3	16.25	41.5	4.57	24	24.1	33	24.4	M4
10	50	49	39.2	19.65	10	6.8	12.35	20.1	49	5	29.2	28	37.7	27	M4

Size	D2 ∅	D3 ∅	D4 ∅	D5 ∅	D6	D7 ∅	EE	H1 ±0.08	H2	H3	H4	H5	H6	H7	H8
4	6.3	5 ^{H7}	3.3	6.2	M4x0.5	3 ^{H7}	M3	16	15.4	15.1	3.85	6.25	8.55	8.1	8.4
6	6.3	5 ^{H7}	3.3	6.2	M5x0.5	3 ^{H7}	M3	20	19	19.25	4.7	7.8	10.2	16.05	10.55
8	8.2	7 ^{H7}	4.3	8	M6x0.5	5 ^{H7}	M3	24	22.7	23	6.46	10.63	14.06	18.9	13.3
10	8.2	7 ^{H7}	4.3	8	M8x1	5 ^{H7}	M5	29	27.1	28	6.8	13.8	15.8	22.8	15.5

Size	H9	H10	H11	H12	H13	H14	H15	H16	H17	H18	H19	T3 +0.1	T4	T5	∅ 2 ¹⁾	∅ 3
4	0.65	0.3	5	8	2.7	5.35	5.85	3.1	10.6	0.25	5.28	1.3	2.25	4	1.5	2
6	0.45	0.5	5	11.5	3.38	6.5	7.2	3.7	13.1	0.3	6.68	1.3	3.7	6	1.5	2.5
8	0.64	0.9	10	8.7	3.28	7.8	10.5	4.1	16.8	0.36	6.7	1.6	3.8	7.5	2	2.5
10	0.6	1.4	10	12.5	4.2	8.76	11.76	4.8	19.25	0.41	9	1.6	5.35	7.5	2.5	3

1) With size 4, the scope of delivery of the drive includes an Allen key

Data sheet

Stroke-dependent dimensions															
Size	Stroke	L1	L2	L5	L6	L7	L8	L9	L10	L11	L15 ±0.05	L16	L17	L18 ±0.05	L21
4	10	72.1	48	28.85	–	–	6.5	5.5	6.6	2.5	4	13.25	4.95	3	31
	20	81.2	57.1	37.95	10										36
	30	91.2	67.1	47.95	11										42
6	10	81.1	54	33.1	–	–	8	8	9.6	2.5	5.1	13.25	4.95	3.5	37
	20	91.1	64	43.1	14										42
	30	101.1	74	53.1	–										47
	40	111.1	84	63.1	–										52
	50	121.1	94	73.1	–										57
8	10	90.2	59.6	34.6	–	–	8	10	11.6	2.5	7	14.65	6.1	5.5	41
	20	100.2	69.6	44.6	10										46
	30	110.2	79.6	54.6	16										51
	40	120.2	89.6	64.6	–										56
	50	142.2	111.6	74.6	–										67
	80	172.2	141.6	104.6	16										82
10	10	103.1	66	41.3	–	–	11	10	11.6	2.5	6.4	18.5	7.5	5	43
	20	112.8	75.7	51	–										46
	30	122.8	85.7	61	–										51
	40	132.8	95.7	71	–										56
	50	142.8	105.7	81	–										61
	80	186.2	149.1	111	24										83
	100	206.2	169.1	131	24										24

Cushioning-dependent dimensions					
Size	Cushioning	L3 max.	L4 max.	≈ 1	
				For adjusting the cushioning stroke	For adjusting the end position
4	P	15.2	7.8	–	1.5
	E	5.7	0	–	1.5
	P1	14	6	1.3	2.5
6	P	17.6	8.1	–	1.5
	E	6.6	0	–	1.5
	P1	15.5	5.8	1.5	3
8	P	21.1	10.7	–	2
	E	6.6	0	–	2
	P1	19	9.1	2	4
	Y3	24.3	23.9	–	2
10	P	22.8	12.5	–	2.5
	E	8.8	0	–	2.5
	P1	20.5	10.2	2.5	5
	Y3	25.5	14.9	–	2.5
	Y11	30.4	19.9	–	2

Data sheet

Hole pattern for mounting threads and centring holes

DGSL-4-10

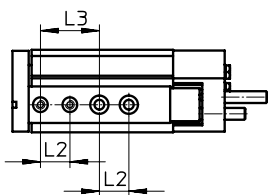

DGSL-4-20

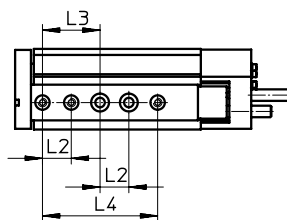

DGSL-4-30

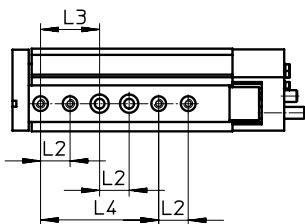

DGSL-6-10

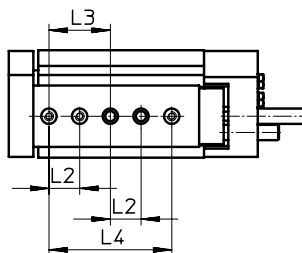

DGSL-6-20

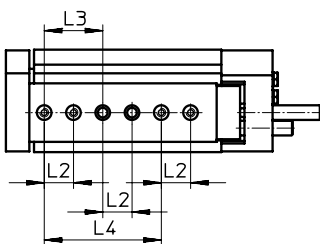

DGSL-6-30

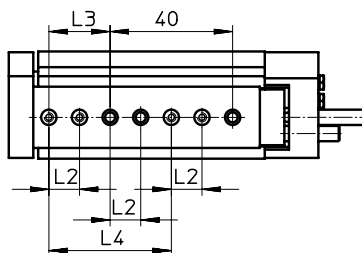

DGSL-6-40/50

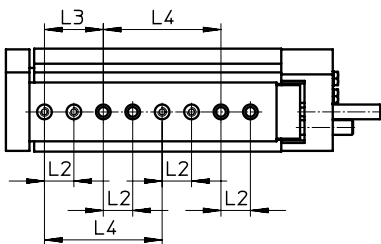

DGSL-8-10

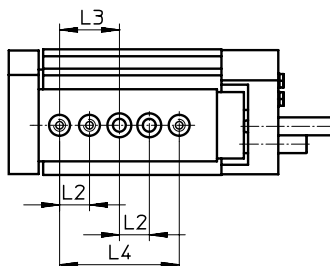

DGSL-8-20

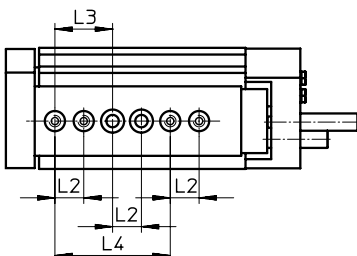

DGSL-8-30

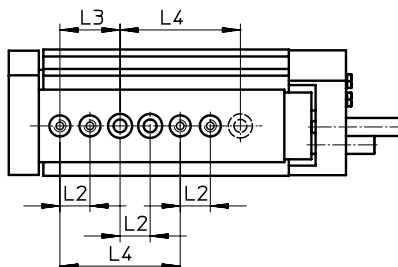

Data sheet

Hole pattern for mounting threads and centring holes

DGSL-8-40

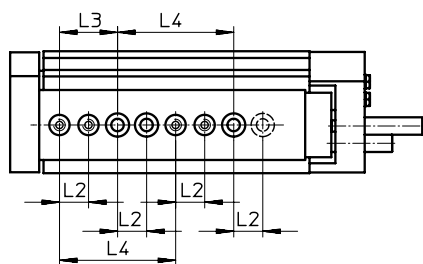

DGSL-8-50/80

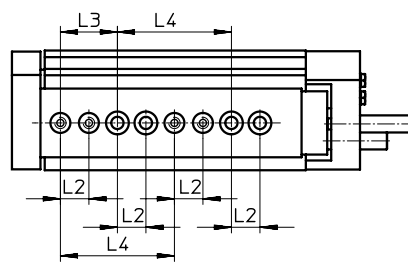

DGSL-10-10

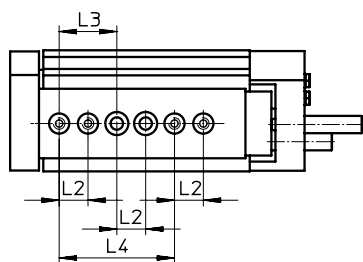

DGSL-10-20

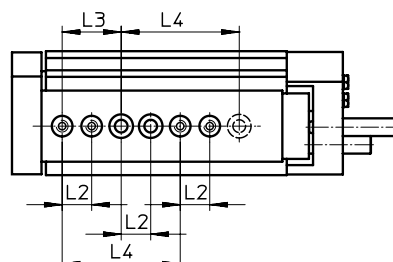

DGSL-10-30

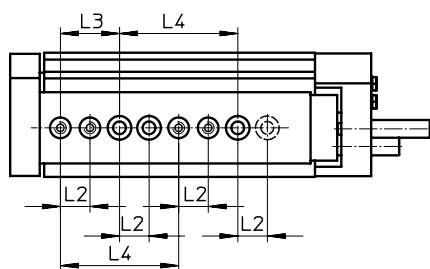

DGSL-10-40 ... 100

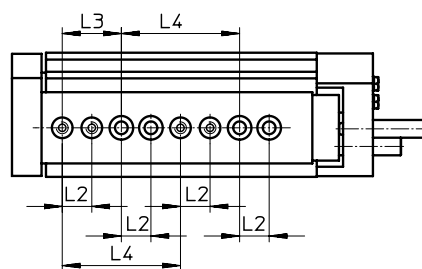

Distances from the yoke plate to the mounting threads and centring holes

DGSL-4 ... 10

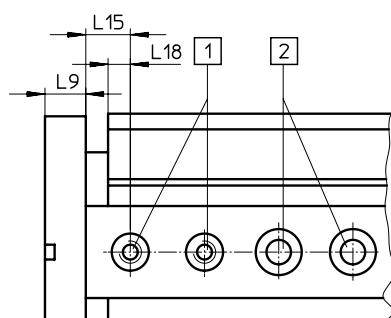

- [1] Centring holes with thread
- [2] Through-holes for mounting the drive

Size	L2 ¹⁾	L3 ¹⁾	L4 ¹⁾	L9	L15 ±0.05	L18
4	10	20	40	5.5	4	3
6	10	20	40	8	5.1	3.5
8	10	20	40	10	7	5.5
10	10	20	40	10	6.4	5

1) Tolerance for centring hole ±0.02
Tolerance for through-hole ±0.1

Data sheet

Dimensions

Download CAD data → www.festo.com

Size 12/16

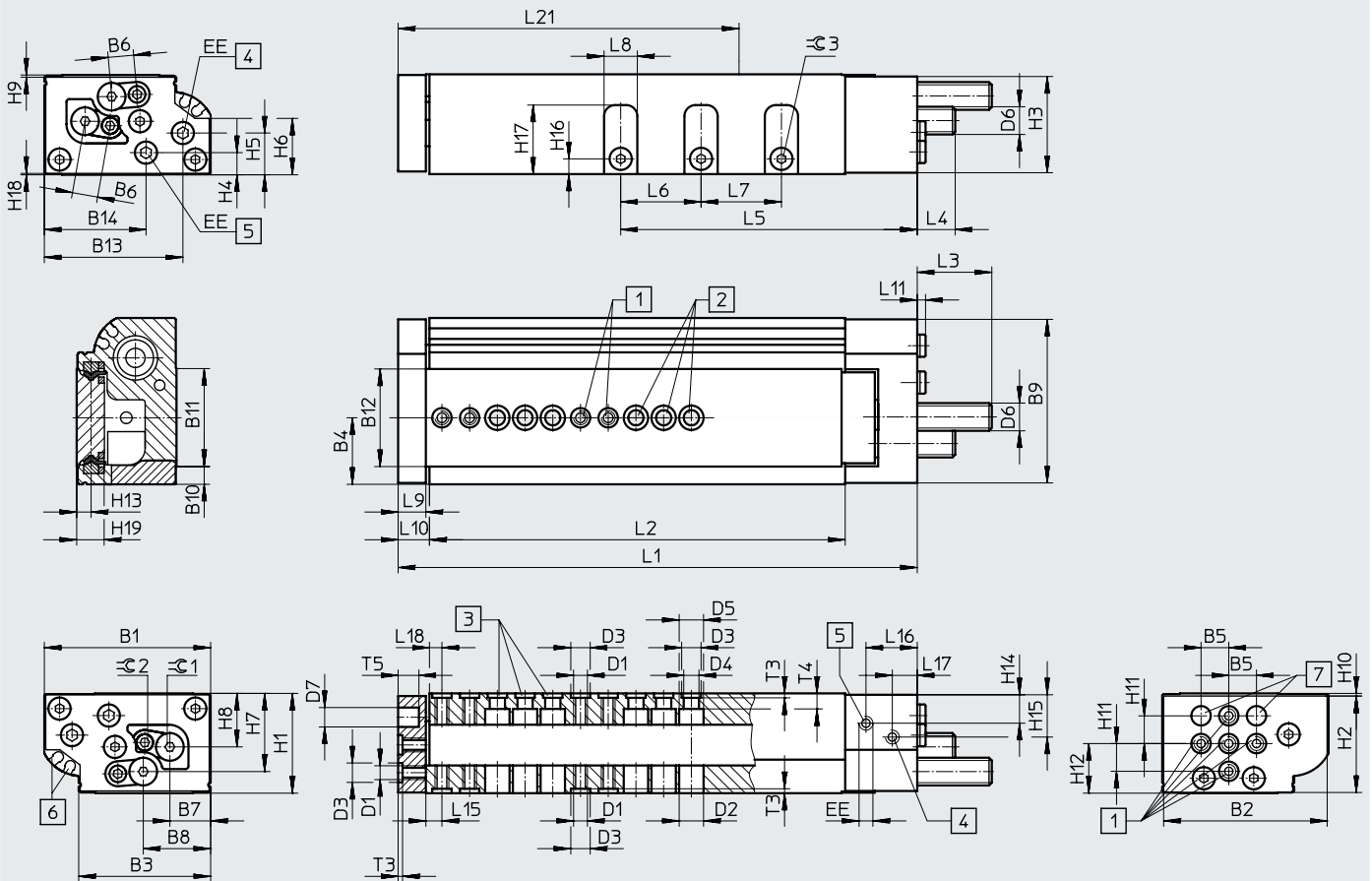

- [1] Mounting thread (centring sleeves included in the scope of delivery)
- [2] Through-holes for mounting the drive
- [3] Centring holes (centring sleeves included in the scope of delivery)
- [4] Supply port, advancing
- [5] Supply port, retracting
- [6] Sensor slots for proximity switch
- [7] Centring hole
- L10 Distance between outer edge of yoke plate and housing
- L15 Distance between centre of centring hole and outer edge of slide
- L18 Distance between centre of centring hole and outer edge of housing

General dimensions

Size	B1	B2	B3	B4	B5	B6	B7	B8	B9	B10	B11	B12	B13	B14	D1
12	60	59	47.6	24	10	9.2	14.7	24.3	59	6.45	35.25	35.2	50	36.7	M5
16	66	65	53.5	26.7	10	11.1	16.7	27.5	65	7.75	37.9	38	50.4	36.7	M5

Size	D2 ∅	D3 ∅	D4 ∅	D5 ∅	D6	D7 ∅	EE	H1 ±0.08	H2	H3	H4	H5	H6	H7	H8
12	9	7 ^{H7}	5.5	9	M10x1	8 ^{H7}	M5	36	34.8	34.7	8	15.1	20.35	28.2	19.3
16	9	7 ^{H7}	5.5	9	M12x1	8 ^{H7}	M5	40	38	39	8.5	16.7	20.6	31.7	20.8

Size	H9	H10	H11	H12	H13	H14	H15	H16	H17	H18	H19	T3 +0.1	T4	T5	∅ 2	∅ 3
12	0.8	0.95	10	17.9	5.2	10.75	15.75	5.5	24.9	0.5	10.1	1.6	5.6	7.5	3	3
16	0.5	1.5	10	20	6.4	10.5	16.7	7	26.6	0.5	12.5	1.6	6.1	9	4	4

Data sheet

Stroke-dependent dimensions																
Size	Stroke	L1	L2	L5	L6	L7	L8	L9	L10	L11	L15 ±0.05	L16	L17	L18 ±0.05	L21	
12	10	106.2	68.6	42.4	-	-	12	10	11.6	2.5	5.8	18.5	9	4.5	44	
	20	116.2	78.6	52.4											49	
	30	126.2	88.6	62.4											54	
	40	136.2	98.6	72.4											59	
	50	146.2	108.6	82.4											64	
	80	197.6	160	112.4											29	88
	100	217.6	180	132.4											29	98
	150	267.6	230	182.4	29	124										
16	10	124.1	82.5	45	-	-	14	12	13.6	2.5	6.8	21	10	5.5	54	
	20	134.6	93	54.6											59	
	30	144.6	103	64.6											64	
	40	154.6	113	74.6											69	
	50	164.6	123	84.6											74	
	80	194.6	153	114.6											35	89
	100	243.6	202	134.6											35	113
	150	293.6	252	184.6	35	138										

Cushioning-dependent dimensions					
Size	Cushioning	L3 max.	L4 max.	≈ 1	
				For adjusting the cushioning stroke	For adjusting the end position
12	P	28.1	14.9	-	3
	E	8.8	0	-	3
	P1	26	12.8	3	6
	Y3	36.9	23.7	-	3
	Y11	42.2	18.7	-	2.5
16	P	42.3	26.1	-	4
	E	8.8	0	-	4
	P1	40	23.8	4	8
	Y3	51.9	35.7	-	4
	Y11	55.4	38.9	-	3

Data sheet

Hole pattern for mounting threads and centring holes

DGSL-12-10

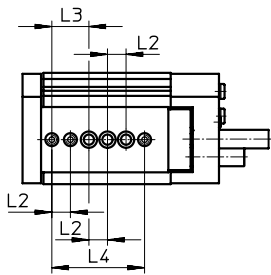

DGSL-12-20

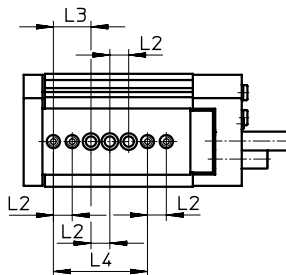

DGSL-12-30

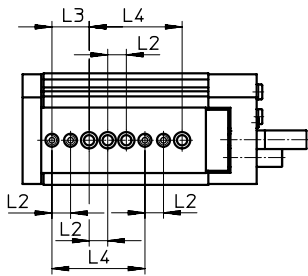

DGSL-12-40

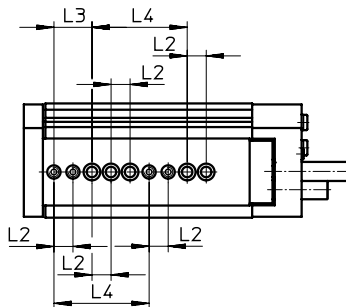

DGSL-12-50 ... 100

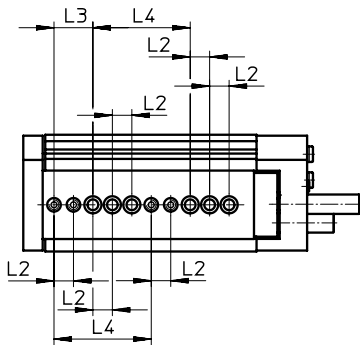

DGSL-12-150

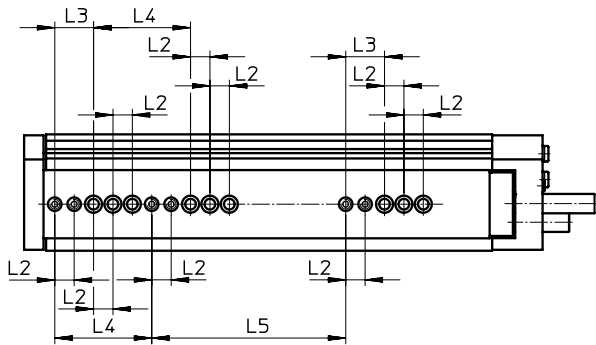

DGSL-16-10

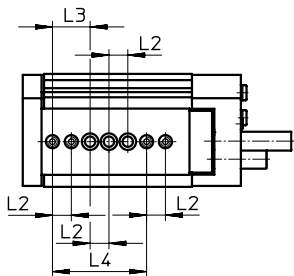

DGSL-16-20

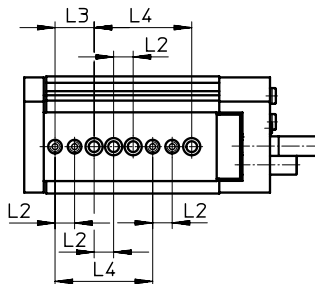

Data sheet

Hole pattern for mounting threads and centring holes

DGSL-16-30

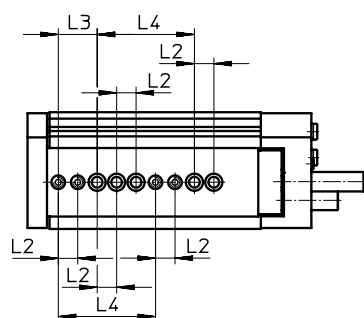

DGSL-16-40 ... 100

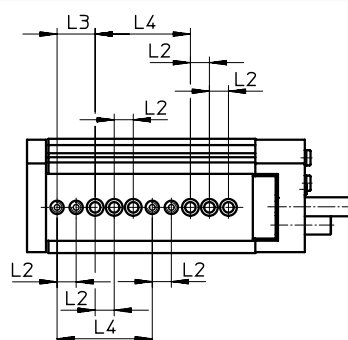

DGSL-16-150

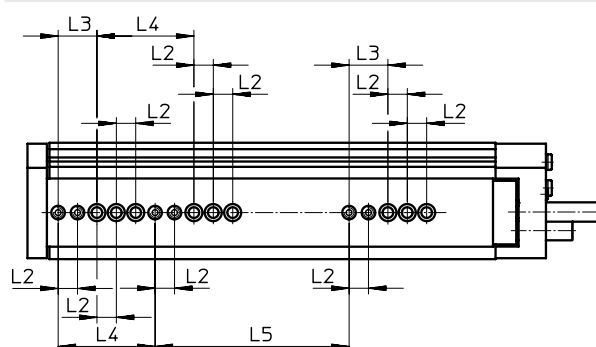

Distances from the yoke plate to the mounting threads and centring holes

DGSL-12/16

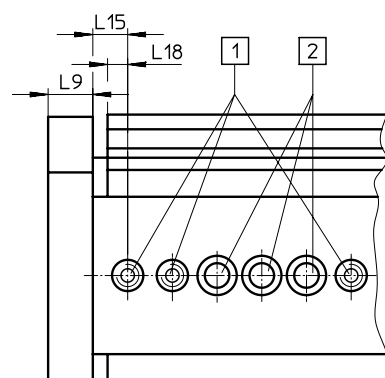

- [1] Centring holes with thread
 [2] Through-holes for mounting the drive

Size	L2 ¹⁾	L3 ¹⁾	L4 ¹⁾	L5 ±0.03	L9	L15 ±0.05	L18 ±0.05
12	10	20	50	100	10	5.8	4.5
16	10	20	50	100	12	6.8	5.5

- 1) Tolerance for centring hole ±0.02
 Tolerance for through-hole ±0.1

Data sheet

Dimensions

Download CAD data → www.festo.com

Size 20/25

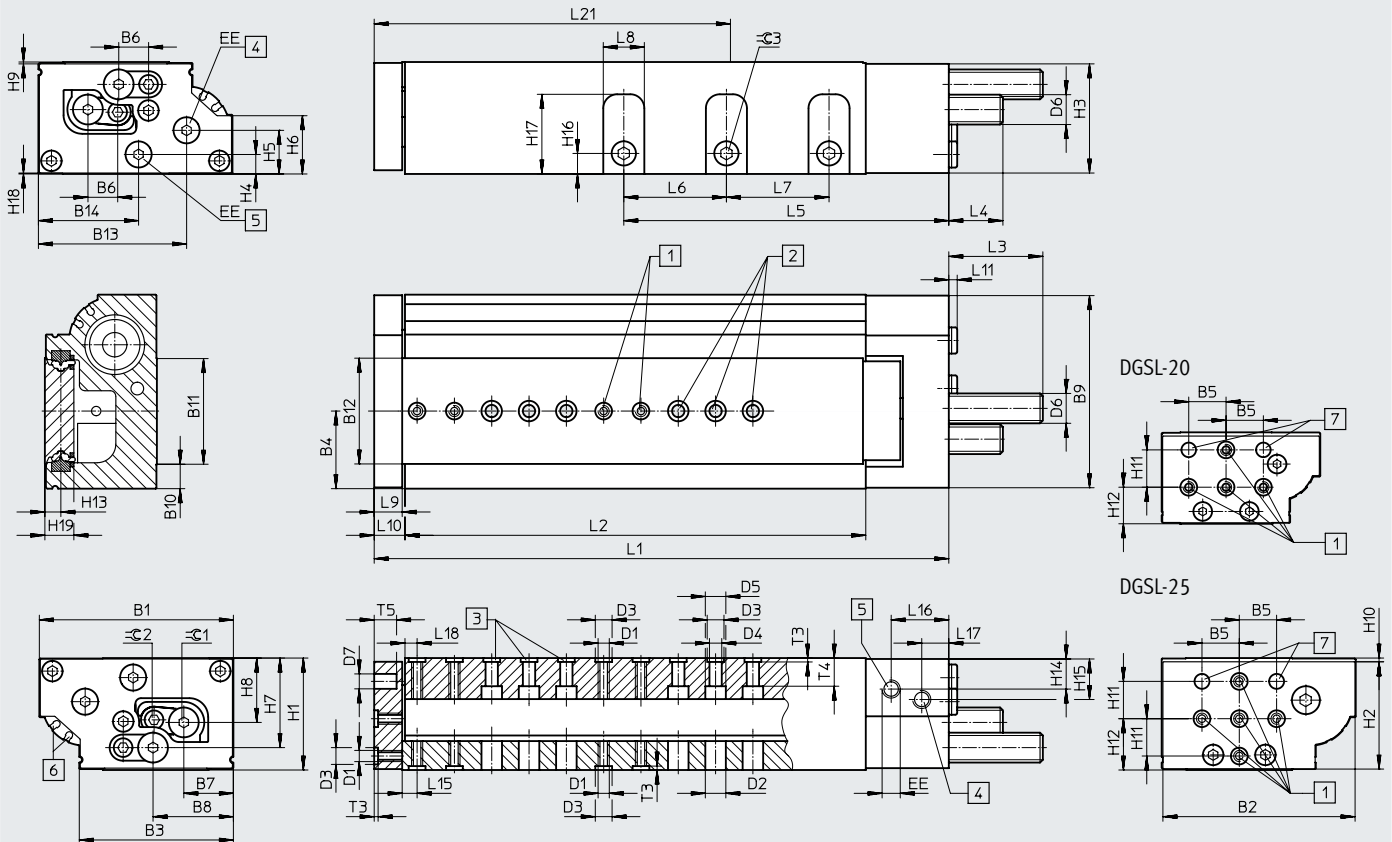

- [1] Mounting thread (centring sleeves included in the scope of delivery)
- [2] Through-holes for mounting the drive
- [3] Centring holes (centring sleeves included in the scope of delivery)
- [4] Supply port, advancing
- [5] Supply port, retracting
- [6] Sensor slots for proximity switch
- [7] Centring hole
- L10 Distance between outer edge of yoke plate and housing
- L15 Distance between centre of centring hole and outer edge of slide
- L18 Distance between centre of centring hole and outer edge of housing

General dimensions

Size	B1	B2	B3	B4	B5	B6	B7	B8	B9	B10	B11	B12	B13	B14	D1
20	85	84	68.85	34.5	20	14.15	21.4	36.35	83.4	10	48.9	49.2	64.1	48.6	M6
25	104	103	82.6	41.6	20	16.2	26.4	43.05	103	13.25	56.5	56.7	79.3	53.65	M6

Size	D2 ∅	D3 ∅	D4 ∅	D5 ∅	D6	D7 ∅	EE	H1 ±0.08	H2	H3	H4	H5	H6	H7	H8
20	11.2	9 ^{H7}	6.6	11	M14x1	8 ^{H7}	G1/8	49	46.5	47.7	10.3	20.6	23.2	38.2	26.1
25	11.2	9 ^{H7}	6.6	11	M16x1	8 ^{H7}	G1/8	60	57.5	58.5	10.45	23.35	31.15	47.95	34.5

Size	H9	H10	H11	H12	H13	H14	H15	H16	H17	H18	H19	T3 +0.1	T4	T5	∅ 2	∅ 3
20	0.5	2	20	19.6	7.55	14.7	14.7	10	33.3	0.8	14.6	2.1	8.6	10	4	5
25	1	2	20	27.5	8.55	16.55	21.15	11	42.7	0.45	15.6	2.1	15	12	5	6

Data sheet

Stroke-dependent dimensions															
Size	Stroke	L1	L2	L5	L6	L7	L8	L9	L10	L11	L15 ±0.05	L16	L17	L18 ±0.05	L21
20	10	141.2	84.6	59.1	–	–	17	14	15.6	4.6	7.8	30.5	12	6.5	56
	20	151.2	94.6	69.1											61
	30	161.2	104.6	79.1											66
	40	171.2	114.6	89.1											71
	50	183.2	126.6	99.1											76
	80	211.2	154.6	129.1	44	44	22	15	16.6	4.6	8	32.3	14.5	6.5	91
	100	270.2	213.6	149.1											121
	150	333.2	276.6	199.1											152
	200	383.2	326.6	252.1											177
25	10	157.1	96	63.7	–	–	22	15	16.6	4.6	8	32.3	14.5	6.5	64
	20	167.1	106	72.2											69
	30	177.1	116	82.2											74
	40	187.1	126	92.2											79
	50	197.1	136	102.2											84
	80	253.1	192	132.2	55	55	22	15	16.6	4.6	8	32.3	14.5	6.5	112
	100	286.1	225	152.2											129
	150	338.1	277	202.2											154
	200	388.1	327	254.2											179

Cushioning-dependent dimensions					
Size	Cushioning	L3 max.	L4 max.	≈ 1	
				For adjusting the cushioning stroke	For adjusting the end position
20	P	52.4	31.2	–	4
	E	8.8	0	–	4
	P1	50.1	28.9	4	8
	Y3	55.5	34.3	–	4
	Y11	67.4	45.9	–	4
25	P	51.9	30.5	–	5
	E	8.8	0	–	5
	P1	49.6	28.2	5	10
	Y3	65.2	43.8	–	5
	Y11	78.4	56.9	–	4

Data sheet

Hole pattern for mounting threads and centring holes

DGSL-20-10/20

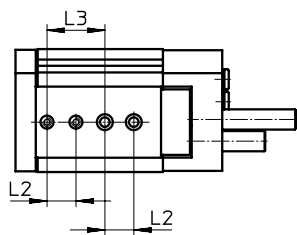

DGSL-20-30/40

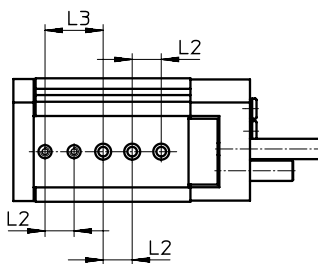

DGSL-20-50

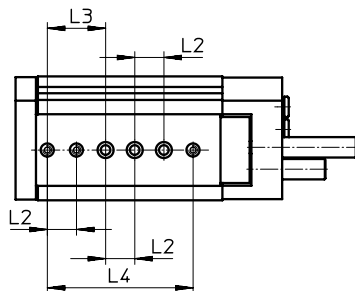

DGSL-20-80

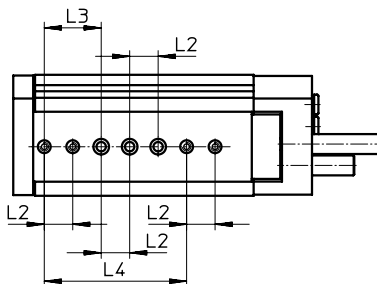

DGSL-20-100 ... 200

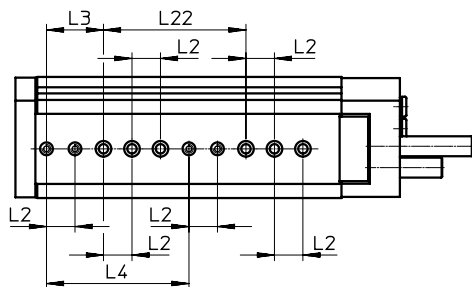

DGSL-25-10

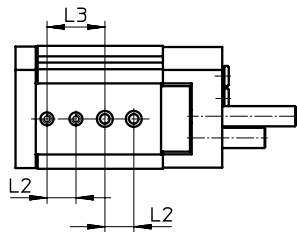

DGSL-25-20

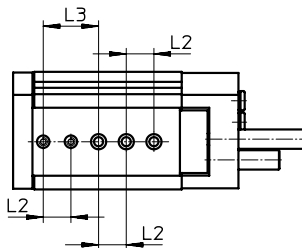

Data sheet

Hole pattern for mounting threads and centring holes

DGSL-25-30/40

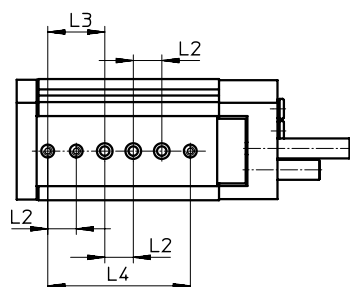

DGSL-25-50

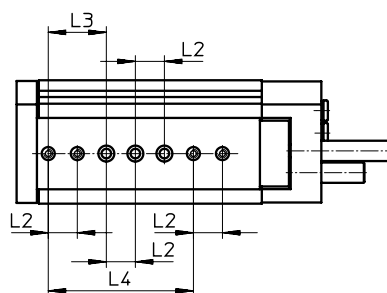

DGSL-25-80

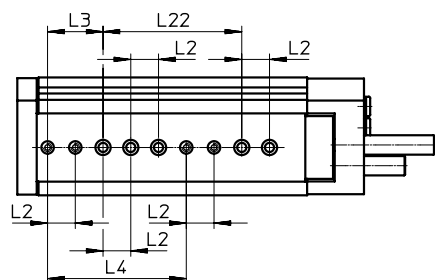

DGSL-25-100 ... 200

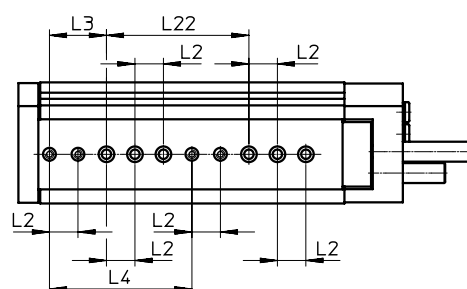

Distances from the yoke plate to the mounting threads and centring holes

DGSL-20/25

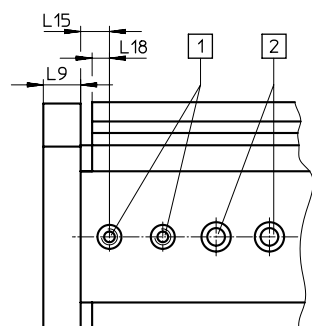

- [1] Centring holes with thread
- [2] Through-holes for mounting the drive

Size	L2 ¹⁾	L3 ¹⁾	L4	L9	L15 ±0.05	L18 +0.05	L22
20	20	40	100 ¹⁾	14	7.8	6.5	100±0.03
25	20	40	100±0.03	15	8	6.5	100 ¹⁾

1) Tolerance for centring hole ±0.02
Tolerance for through-hole ±0.1

Data sheet

Function
C – Clamping unit

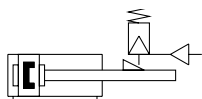

E3 – End-position locking

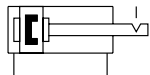

Size
6 ... 25

Sets of wearing parts
→ Page 45



Note

If used in safety-relevant applications, additional measures are necessary, e.g. in Europe the standards listed in the EC Machinery Directive must be observed. Without additional measures in accordance with legally specified minimum requirements, the product is not suitable as a safety-related component in control systems.

General technical data – Clamping unit							
Size	6	8	10	12	16	20	25
Function	<ul style="list-style-type: none"> Mechanical clamping For fixing the slide in any position Frictional locking 						
Type of clamping with effective direction	At both ends Clamping via spring force, compressed air to release						
Pneumatic connection	M5						
Mounting position	Any						
Static holding force [N]	80	80	180	180	350	350	600
Product weight [g]	10	10	15	15	50	50	50

Operating and environmental conditions – Clamping unit	
Operating medium	Compressed air to ISO 8573-1:2010 [7:4:4]
Note on the operating/pilot medium	Lubricated operation possible (in which case lubricated operation will always be required)
Min. release pressure	
	[MPa] 0.3
	[bar] 3
Max. operating pressure	
	[MPa] ≤ 1
	[bar] ≤ 10

General technical data – End-position locking							
Size	6	8	10	12	16	20	25
Function	<ul style="list-style-type: none"> Mechanical locking when the end position is reached For fixing the slide in the unpressurised, retracted state Form-fitting 						
Type of clamping with effective direction	At both ends Clamping via spring force, unlocked via compressed air						
Pneumatic connection	M5						
Mounting position	Any						
Static holding force [N]	60	60	160	160	250	380	640
Product weight [g]	13	13	26	26	64	64	65

Operating and environmental conditions – End-position locking	
Operating medium	Compressed air to ISO 8573-1:2010 [7:4:4]
Note on the operating/pilot medium	Lubricated operation possible (in which case lubricated operation will always be required)
Operating pressure	
	[MPa] 0.3 ... 0.8
	[bar] 3 ... 8

Data sheet

Adjustable end-position range

When using end-position locking (E3), the adjustable end-position range, the retracted end position, is reduced by the following values.

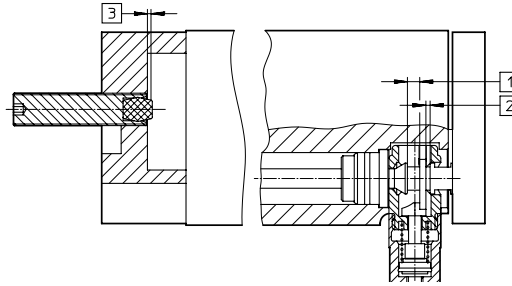

Size	[3]
6, 8	Max. 1.5 mm
10, 12	Max. 2.3 mm
16, 20, 25	Max. 2.7 mm

- [1] Axial setting range
- [2] Max. cushioning stroke
- [3] Adjustable end-position range

Dimensions

Download CAD data → www.festo.com

C – Clamping unit/E3 – End-position locking

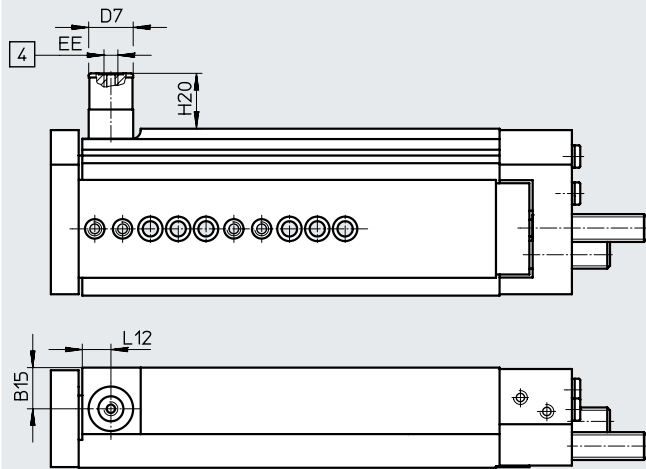

[4] Supply port

Size	B15	D7 ∅	EE	H20		L12
				C	E3	
6	7.2	12	M5	10.7	21.2	7.3
8	9.9	12		10.5	21	7.3
10	11.2	16		11.8	21.2	10.5
12	14.8	16		10.5	19.9	10.3
16	14	20		27.5	30.5	13
20	17	20		21.3	24.3	14
25	22.55	20		17.75	20.65	14

Data sheet

★ Core Range

Ordering data							
Size	Stroke [mm]	Part no.	Type	Size	Stroke [mm]	Part no.	Type
With cushioning P				With cushioning Y3			
8	10	★ 543926	DGSL-8-10-PA	8	10	-	
	20	★ 543927	DGSL-8-20-PA		20		
	30	★ 543928	DGSL-8-30-PA		30	★ 543938	DGSL-8-30-Y3A
	40	★ 543929	DGSL-8-40-PA		40	★ 543939	DGSL-8-40-Y3A
	50	★ 543930	DGSL-8-50-PA		50	★ 543940	DGSL-8-50-Y3A
	80	★ 543931	DGSL-8-80-PA		80	★ 543941	DGSL-8-80-Y3A
10	10	★ 543942	DGSL-10-10-PA	10	10	-	
	20	★ 543943	DGSL-10-20-PA		20		
	30	★ 543944	DGSL-10-30-PA		30	★ 543956	DGSL-10-30-Y3A
	40	★ 543945	DGSL-10-40-PA		40	★ 543957	DGSL-10-40-Y3A
	50	★ 543946	DGSL-10-50-PA		50	★ 543958	DGSL-10-50-Y3A
	80	★ 543947	DGSL-10-80-PA		80	★ 543959	DGSL-10-80-Y3A
	100	★ 543948	DGSL-10-100-PA	100	★ 543960	DGSL-10-100-Y3A	
12	10	★ 543961	DGSL-12-10-PA	12	10	-	
	20	★ 543962	DGSL-12-20-PA		20		
	30	★ 543963	DGSL-12-30-PA		30	★ 543977	DGSL-12-30-Y3A
	40	★ 543964	DGSL-12-40-PA		40	★ 543978	DGSL-12-40-Y3A
	50	★ 543965	DGSL-12-50-PA		50	★ 543979	DGSL-12-50-Y3A
	80	★ 543966	DGSL-12-80-PA		80	★ 543980	DGSL-12-80-Y3A
	100	★ 543967	DGSL-12-100-PA		100	★ 543981	DGSL-12-100-Y3A
	150	★ 543968	DGSL-12-150-PA	150	★ 543982	DGSL-12-150-Y3A	
16	10	★ 543983	DGSL-16-10-PA	16	10	-	
	20	★ 543984	DGSL-16-20-PA		20		
	30	★ 543985	DGSL-16-30-PA		30	★ 543999	DGSL-16-30-Y3A
	40	★ 543986	DGSL-16-40-PA		40	★ 544000	DGSL-16-40-Y3A
	50	★ 543987	DGSL-16-50-PA		50	★ 544001	DGSL-16-50-Y3A
	80	★ 543988	DGSL-16-80-PA		80	★ 544002	DGSL-16-80-Y3A
	100	★ 543989	DGSL-16-100-PA		100	★ 544003	DGSL-16-100-Y3A
	150	★ 543990	DGSL-16-150-PA	150	★ 544004	DGSL-16-150-Y3A	
20	10	★ 544005	DGSL-20-10-PA	20	10	-	
	20	★ 544006	DGSL-20-20-PA		20		
	30	★ 544007	DGSL-20-30-PA		30	★ 544023	DGSL-20-30-Y3A
	40	★ 544008	DGSL-20-40-PA		40	★ 544024	DGSL-20-40-Y3A
	50	★ 544009	DGSL-20-50-PA		50	★ 544025	DGSL-20-50-Y3A
	80	★ 544010	DGSL-20-80-PA		80	★ 544026	DGSL-20-80-Y3A
	100	★ 544011	DGSL-20-100-PA		100	★ 544027	DGSL-20-100-Y3A
	150	★ 544012	DGSL-20-150-PA		150	★ 544028	DGSL-20-150-Y3A
	200	★ 544013	DGSL-20-200-PA	200	★ 544029	DGSL-20-200-Y3A	

Data sheet

Ordering data							
Size	Stroke [mm]	Part no.	Type	Size	Stroke [mm]	Part no.	Type
With cushioning P				With cushioning Y3			
4	10	543910	DGSL-4-10-PA	4	10	-	
	20	543911	DGSL-4-20-PA		20		
	30	543912	DGSL-4-30-PA		30		
6	10	543916	DGSL-6-10-PA	6	10	-	
	20	543917	DGSL-6-20-PA		20		
	30	543918	DGSL-6-30-PA		30		
	40	543919	DGSL-6-40-PA		40		
	50	543920	DGSL-6-50-PA		50		
25	10	544030	DGSL-25-10-PA	25	10	-	
	20	544031	DGSL-25-20-PA		20		
	30	544032	DGSL-25-30-PA	30	544048	DGSL-25-30-Y3A	
	40	544033	DGSL-25-40-PA	40	544049	DGSL-25-40-Y3A	
	50	544034	DGSL-25-50-PA	50	544050	DGSL-25-50-Y3A	
	80	544035	DGSL-25-80-PA	80	544051	DGSL-25-80-Y3A	
	100	544036	DGSL-25-100-PA	100	544052	DGSL-25-100-Y3A	
	150	544037	DGSL-25-150-PA	150	544053	DGSL-25-150-Y3A	
	200	544038	DGSL-25-200-PA	200	544054	DGSL-25-200-Y3A	

Data sheet

Ordering data							
Size	Stroke [mm]	Part no.	Type	Size	Stroke [mm]	Part no.	Type
With cushioning P1				With cushioning E			
4	10	543913	DGSL-4-10-P1A	4	10	570158	DGSL-4-10-EA
	20	543914	DGSL-4-20-P1A		20	570159	DGSL-4-20-EA
	30	543915	DGSL-4-30-P1A		30	570160	DGSL-4-30-EA
6	10	543921	DGSL-6-10-P1A	6	10	570161	DGSL-6-10-EA
	20	543922	DGSL-6-20-P1A		20	570162	DGSL-6-20-EA
	30	543923	DGSL-6-30-P1A		30	570163	DGSL-6-30-EA
	40	543924	DGSL-6-40-P1A		40	570164	DGSL-6-40-EA
	50	543925	DGSL-6-50-P1A		50	570165	DGSL-6-50-EA
8	10	543932	DGSL-8-10-P1A	8	10	570166	DGSL-8-10-EA
	20	543933	DGSL-8-20-P1A		20	570167	DGSL-8-20-EA
	30	543934	DGSL-8-30-P1A		30	570168	DGSL-8-30-EA
	40	543935	DGSL-8-40-P1A		40	570169	DGSL-8-40-EA
	50	543936	DGSL-8-50-P1A		50	570170	DGSL-8-50-EA
10	80	543937	DGSL-8-80-P1A	80	570171	DGSL-8-80-EA	
	10	543949	DGSL-10-10-P1A	10	10	570172	DGSL-10-10-EA
	20	543950	DGSL-10-20-P1A		20	570173	DGSL-10-20-EA
	30	543951	DGSL-10-30-P1A		30	570174	DGSL-10-30-EA
	40	543952	DGSL-10-40-P1A		40	570175	DGSL-10-40-EA
	50	543953	DGSL-10-50-P1A		50	570176	DGSL-10-50-EA
	80	543954	DGSL-10-80-P1A		80	570177	DGSL-10-80-EA
100	543955	DGSL-10-100-P1A	100		570178	DGSL-10-100-EA	
12	10	543969	DGSL-12-10-P1A	12	10	570179	DGSL-12-10-EA
	20	543970	DGSL-12-20-P1A		20	570180	DGSL-12-20-EA
	30	543971	DGSL-12-30-P1A		30	570181	DGSL-12-30-EA
	40	543972	DGSL-12-40-P1A		40	570182	DGSL-12-40-EA
	50	543973	DGSL-12-50-P1A		50	570183	DGSL-12-50-EA
	80	543974	DGSL-12-80-P1A		80	570184	DGSL-12-80-EA
	100	543975	DGSL-12-100-P1A		100	570185	DGSL-12-100-EA
	150	543976	DGSL-12-150-P1A	150	570186	DGSL-12-150-EA	

Data sheet

Ordering data							
Size	Stroke [mm]	Part no.	Type	Size	Stroke [mm]	Part no.	Type
16	10	543991	DGSL-16-10-P1A	16	10	570187	DGSL-16-10-EA
	20	543992	DGSL-16-20-P1A		20	570188	DGSL-16-20-EA
	30	543993	DGSL-16-30-P1A		30	570189	DGSL-16-30-EA
	40	543994	DGSL-16-40-P1A		40	570190	DGSL-16-40-EA
	50	543995	DGSL-16-50-P1A		50	570191	DGSL-16-50-EA
	80	543996	DGSL-16-80-P1A		80	570192	DGSL-16-80-EA
	100	543997	DGSL-16-100-P1A		100	570193	DGSL-16-100-EA
	150	543998	DGSL-16-150-P1A		150	570194	DGSL-16-150-EA
20	10	544014	DGSL-20-10-P1A	20	10	570195	DGSL-20-10-EA
	20	544015	DGSL-20-20-P1A		20	570196	DGSL-20-20-EA
	30	544016	DGSL-20-30-P1A		30	570197	DGSL-20-30-EA
	40	544017	DGSL-20-40-P1A		40	570198	DGSL-20-40-EA
	50	544018	DGSL-20-50-P1A		50	570199	DGSL-20-50-EA
	80	544019	DGSL-20-80-P1A		80	570200	DGSL-20-80-EA
	100	544020	DGSL-20-100-P1A		100	570201	DGSL-20-100-EA
	150	544021	DGSL-20-150-P1A		150	570202	DGSL-20-150-EA
25	10	544039	DGSL-25-10-P1A	25	10	570204	DGSL-25-10-EA
	20	544040	DGSL-25-20-P1A		20	570205	DGSL-25-20-EA
	30	544041	DGSL-25-30-P1A		30	570206	DGSL-25-30-EA
	40	544042	DGSL-25-40-P1A		40	570207	DGSL-25-40-EA
	50	544043	DGSL-25-50-P1A		50	570208	DGSL-25-50-EA
	80	544044	DGSL-25-80-P1A		80	570209	DGSL-25-80-EA
	100	544045	DGSL-25-100-P1A		100	570210	DGSL-25-100-EA
	150	544046	DGSL-25-150-P1A		150	570211	DGSL-25-150-EA
	200	544047	DGSL-25-200-P1A	200	570212	DGSL-25-200-EA	

Ordering data for modular products → page 46

Ordering data – Sets of wearing parts					
Size	Part no.	Type	Size	Part no.	Type
4	713743	DGSL-4-...	12	713747	DGSL-12-...
6	713744	DGSL-6-...	16	713748	DGSL-16-...
8	713745	DGSL-8-...	20	713749	DGSL-20-...
10	713746	DGSL-10-...	25	713750	DGSL-25-...

Ordering data – Modular product system

Ordering table												
Size	4	6	8	10	12	16	20	25	Conditions	Code	Enter code	
Module no.	543902	543903	543904	543905	543906	543907	543908	543909				
Function	Mini slide with recirculating ball bearing guide									DGSL	DGSL	
Size	4	6	8	10	12	16	20	25		-...		
Stroke [mm]	10									-10		
	20									-20		
	30									-30		
	-	40									-40	
	-	50									-50	
	-	-	80							-80		
	-	-	-	100						-100		
	-	-	-	-	150					-150		
	-	-	-	-	-	-	200				-200	
Clamping unit	-	Attached								-C		
End-position locking	-	With retracted piston rod							[1]	-E3		
Cushioning	Elastic cushioning rings/pads at both ends, end positions adjustable									-P		
	Elastic cushioning rings/pads at both ends, end positions adjustable, with fixed stop									-P1		
	-	Progressive shock absorber, at both ends							[2]	-Y3		
	Elastic cushioning rings/pads at both ends, end positions adjustable, short design									-E		
	-	Progressive shock absorber with reducing sleeve, at both ends							[2]	-Y11		
	No cushioning									[2]	-N	
Position sensing	Via proximity switch									A	A	

[1] **E3** Not with clamping unit C

[2] **Y3, Y11** Minimum stroke 30 mm

Accessories

Covering DADS

Material:
Anodised aluminium
Free of copper and PTFE
RoHS-compliant

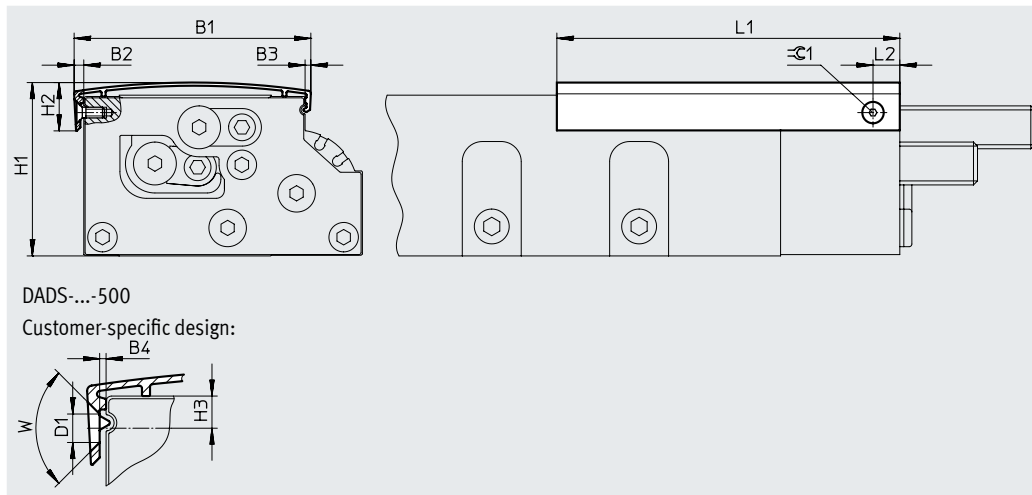

Dimensions and ordering data

For size	Length [mm]	B1	B2	B3	B4	D1	H1	H2	H3	L1	L2	W	≙1	Weight [g]	Part no.	Type
4	30	22	1.9	-	0.4	2.8	17.9	7.5	2	40	4.5	90°	-	2	1086663	DADS-AB-G6-4-30
	500									27				1212468	DADS-AB-G6-4-500	
6	50	31.2	1.4	-	0	2.8	22	8.2	2.5	63	6	90°	-	4	1066625	DADS-AB-G6-6-50
	500									33				1212476	DADS-AB-G6-6-500	
8	80	36.3	1.9	-	0.3	2.8	26.5	8.2	2	93	7	90°	-	8	1087413	DADS-AB-G6-8-80
	500									42				1212478	DADS-AB-G6-8-500	
10	50	43.6	2.8	2.2	1.2	3.4	32	12	3.4	70	10	90°	2	11	1162400	DADS-AB-G6-10-50
	100									18				1090689	DADS-AB-G6-10-100	
	500									75				1212479	DADS-AB-G6-10-500	
12	50	51.7	2.7	2	0.5	3.4	38.8	12.8	4.25	72	10	90°	2	12	1162406	DADS-AB-G6-12-50
	150									28				1090732	DADS-AB-G6-12-150	
	500									82				1212480	DADS-AB-G6-12-500	
16	50	60	4.3	3.1	2.25	3.4	43.7	15.2	5	73	10	90°	2	21	1162410	DADS-AB-G6-16-50
	150									49				1066591	DADS-AB-G6-16-150	
	500									141				1212503	DADS-AB-G6-16-500	
20	50	74.8	3.6	2.8	1.2	4.4	53.2	18.9	6.5	74	10	90°	2.5	28	1162412	DADS-AB-G6-20-50
	100									46				1162415	DADS-AB-G6-20-100	
	200									83				1090823	DADS-AB-G6-20-200	
	500									184				1212521	DADS-AB-G6-20-500	
25	50	88.4	3.5	2.7	0.7	4.4	64.7	18.3	6	78	10	90°	2.5	34	1162417	DADS-AB-G6-25-50
	100									128				1162419	DADS-AB-G6-25-100	
	200									228				1090895	DADS-AB-G6-25-200	
	500									500				213	1212523	DADS-AB-G6-25-500

 **Note**
With the 500 mm covers, the mounting hole must be made by the customer.

The cover can be shortened as required by the customer.

Accessories

Intermediate-position module DADM

- The intermediate-position module enables an additional adjustable position within the stroke range. The module is mounted separately, directly next to the mini slide. It can be mounted anywhere along the mini slide.
- The associated shock absorber retainer → page 50 can be attached at several points on the slide. The position can be precisely set with the help of the shock absorber.
- The stop lever positions can be sensed using proximity switches SME/SMT → page 53
- Push-in fittings are not included in the scope of delivery

Material:
Housing:
Wrought aluminium alloy
Lever:
High-alloy stainless steel
RoHS-compliant

Dimensions and ordering data

Data sheets → Internet: dadm

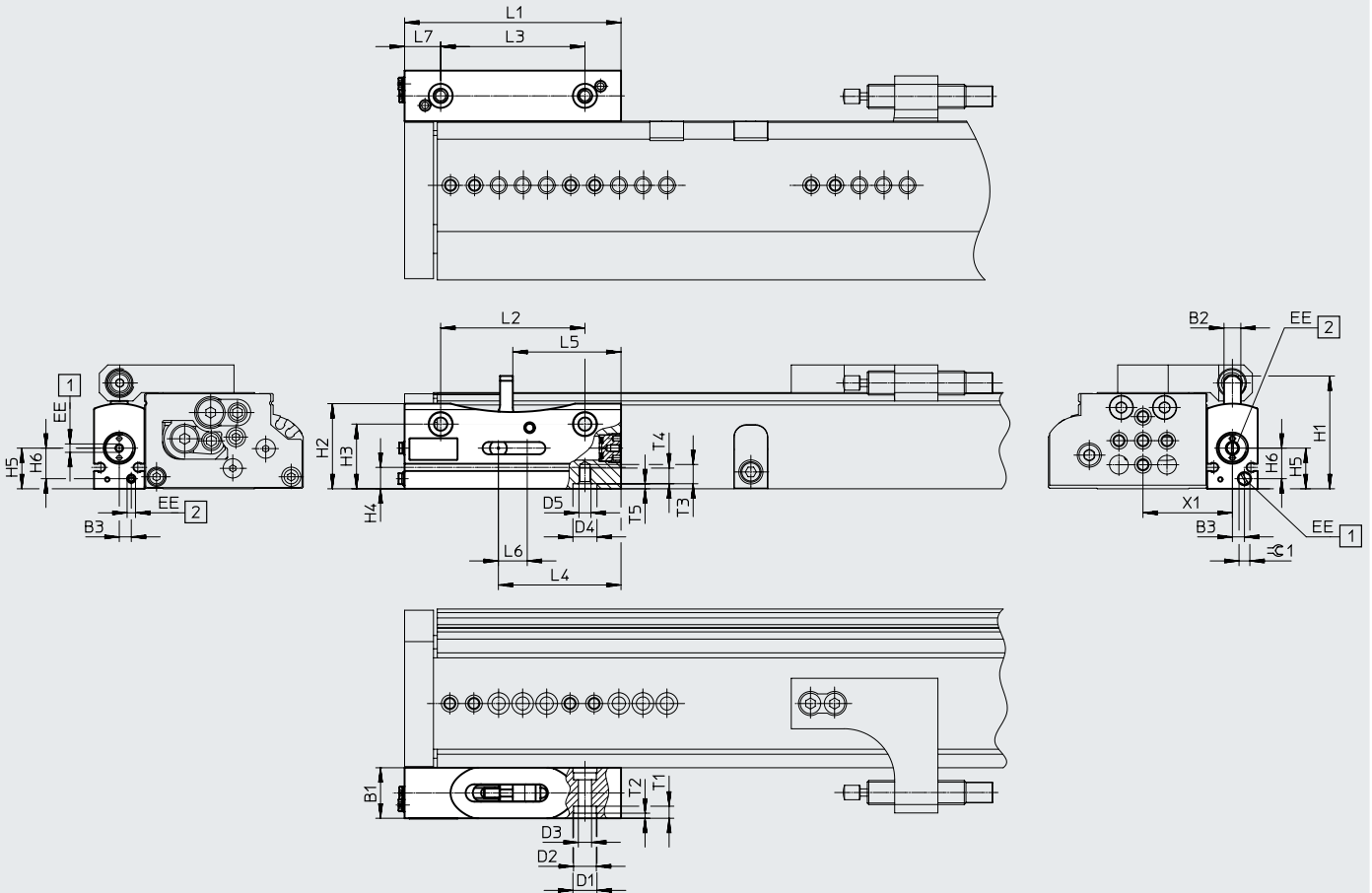

- [1] Swivel stop lever in
- [2] Swivel stop lever out



Note
With DADM-EP-G6-10: SME/SMT-10
With DADM-EP-G6-16: SME/SMT-8

For size	B1	B2	B3	D1	D2	D3	D4	D5	EE	H1	H2
			±0.1	∅ H7	∅	∅	∅ H7				
12, 16	21	7	5	10	9.5	5.5	10	M5	M3	46.9	35.4
20, 25	26.5	9	5.5	12	11	6.6	12	M6	M5	65.2	47.4

Accessories

For size	H3	H4	H5	H6	L1	L2	L3	L4	L5	L6	L7
	±0.1		±0.1	±0.1		±0.1	±0.1				
12, 16	26.9	8.9	16.9	12.7	90	60	60	51	45	12	15
20, 25	36.4	12.4	23.4	17	120	80	80	68	60	16	20

For size	T1	T2	T3	T4	T5	X1	≙1	Weight	Part no.	Type
		+0.2			+0.1			[g]		
12	5	2.1	8	6.5	2.1	34.7 ^{+0.35}	4.5	154	1492072	DADM-EP-G6-10
16						37.4 ^{+0.45}				
20	6.8	2.1	10	8	2.1	48 ^{+0.5}	2.5	340	1478121	DADM-EP-G6-16
25						55.1 ^{+0.5}				

Ordering data					
	For size	Description	Part no.	Type	PU ¹⁾
Connector sleeve ZBV Data sheets → Internet: zbv					
	12, 16	For centring the intermediate-position module (2 pieces included in the scope of delivery for the intermediate-position module)	560254	ZBV-10-9	10
Centring sleeve ZBH Data sheets → Internet: zbh					
	20, 25	For centring the intermediate-position module (2 pieces included in the scope of delivery for the intermediate-position module)	8137185	ZBH-12-B	10

1) Packaging unit

Mounting

To ensure that the shock absorber strikes the stop lever centrally, we recommend mounting the intermediate-position module directly next to the mini slide (without a gap). It is fastened on the mounting surface using 2 screws and centring sleeves.

The shock absorber retainer is then attached to the slide of the mini slide, likewise using 2 screws and centring sleeves.

Precision adjustment:

The required stroke reduction can be precisely adjusted using the screw-in depth of the shock absorber. The shock absorber must protrude by at least 1.5 mm.

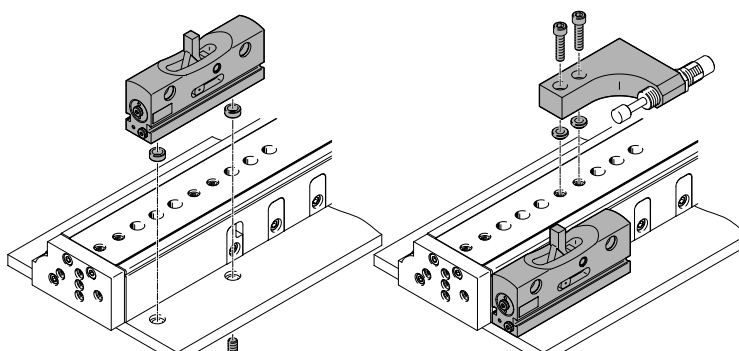

Accessories

Shock absorber retainer DADP

Material:
Anodised wrought aluminium alloy
RoHS-compliant

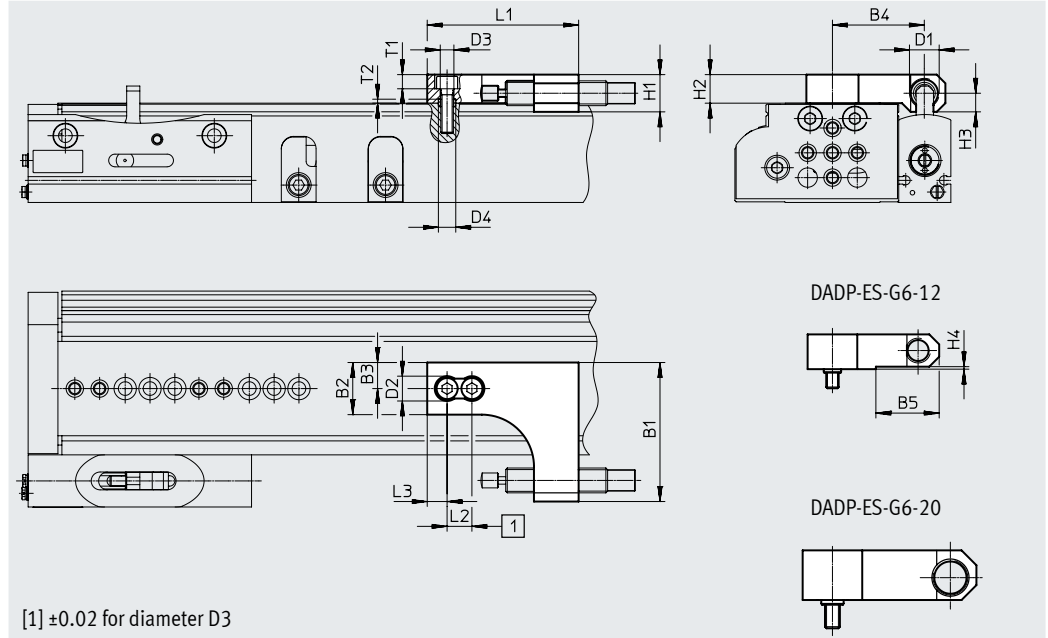
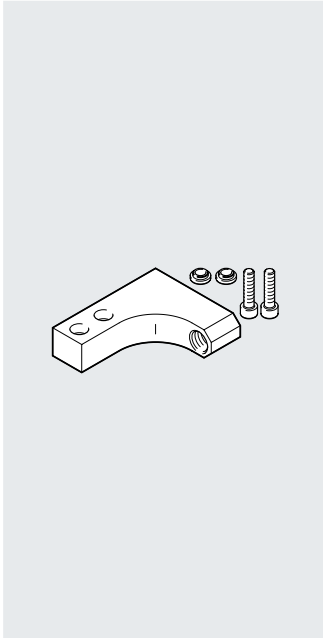

[1] ±0.02 for diameter D3

DADP-ES-G6-12

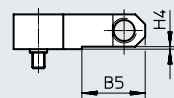

DADP-ES-G6-20

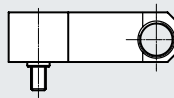

Dimensions and ordering data

For size	B1	B2	B3	B4	B5	D1	D2 ∅	D3 ∅	D4 ∅ H7	H1	H2
12	53	20	10	34.5	25.5	M10x1	10	5.5	7	13	14
16	56	21	10.5	37	39.2	M12x1	10	5.5	7	15	12.2
20	70	24	12	47.5	-	M14x1	11	6.6	12	20	20
25	80	30	15	54.5	58	M16x1	11	6.6	12	25	14

For size	H3	H4	L1	L2	L3	T1	T2	Weight [g]	Part no.	Type
12	6.5	1	65	10	10	5.7	1.6	80	1812471	DADP-ES-G6-12
16	7.5	2.8	61	10	8	5.7	1.6	70	1812472	DADP-ES-G6-16
20	9	-	85	20	10	6.4	2.6	185	1812473	DADP-ES-G6-20
25	10	11	80	20	10	6.8	2.6	160	1812550	DADP-ES-G6-25

Ordering data





	For size	Description	Part no.	Type	PU ¹⁾
Centring sleeve ZBH Data sheets → Internet: zbh					
	12, 16	For centring the shock absorber retainer (2 pieces included in the scope of delivery of the shock absorber retainer)	186717	ZBH-7	10
Connector sleeve ZBV Data sheets → Internet: zbv					
	20, 25	For centring the shock absorber retainer (2 pieces included in the scope of delivery of the shock absorber retainer)	548806	ZBV-12-9	10

1) Packaging unit

Note



- A shock absorber retainer DADP-ES is additionally required when using an intermediate-position module
- Operation without cushioning components is not permitted
- Cushioning components are not included in the scope of delivery
- The shock absorbers for the mini slides and for the relevant shock absorber retainer are of identical size. Shock absorber selection → page 51
- The same cushioning component as is used in the end positions of the mini slide is used for cushioning the intermediate position

Accessories



Ordering data							
	For size	For shock absorber retainer	Description	Order code	Part no.	Type	PJ ¹⁾
Shock absorber DYEF-....Y1 Data sheets → Internet: dyef							
	4	–	Elastic cushioning, without metal stop	P	1179810	DYEF-M4-Y1	1
	6	–			1179818	DYEF-M5-Y1	
	8	–			1179831	DYEF-M6-Y1	
	10	–			1179834	DYEF-M8-Y1	
	12	DADP-ES-G6-12			1179837	DYEF-M10-Y1	
	16	DADP-ES-G6-16			1179840	DYEF-M12-Y1	
	20	DADP-ES-G6-20			1179863	DYEF-M14-Y1	
	25	DADP-ES-G6-25			1179879	DYEF-M16-Y1	
Shock absorber DYEF-S-....Y1 Data sheets → Internet: dyef							
	4	–	Elastic cushioning, without metal stop, short design	E	1152500	DYEF-S-M4-Y1	1
	6	–			1152507	DYEF-S-M5-Y1	
	8	–			1152524	DYEF-S-M6-Y1	
	10	–			1152536	DYEF-S-M8-Y1	
	12	DADP-ES-G6-12			1152959	DYEF-S-M10-Y1	
	16	DADP-ES-G6-16			1153004	DYEF-S-M12-Y1	
	20	DADP-ES-G6-20			1153017	DYEF-S-M14-Y1	
	25	DADP-ES-G6-25			1153023	DYEF-S-M16-Y1	
Shock absorber DYEF-....Y1F Data sheets → Internet: dyef							
	4	–	Elastic cushioning, with metal stop	P1	548370	DYEF-M4-Y1F	1
	6	–			548371	DYEF-M5-Y1F	
	8	–			548372	DYEF-M6-Y1F	
	10	–			548373	DYEF-M8-Y1F	
	12	DADP-ES-G6-12			548374	DYEF-M10-Y1F	
	16	DADP-ES-G6-16			548375	DYEF-M12-Y1F	
	20	DADP-ES-G6-20			548376	DYEF-M14-Y1F	
	25	DADP-ES-G6-25			548377	DYEF-M16-Y1F	
Shock absorber DYSW Data sheets → Internet: dysw							
	8	–	Progressive shock absorber, at both ends	Y3	548070	DYSW-4-6-Y1F	1
	10	–			548071	DYSW-5-8-Y1F	
	12	DADP-ES-G6-12			548072	DYSW-7-10-Y1F	
	16	DADP-ES-G6-16			548073	DYSW-8-14-Y1F	
	20	DADP-ES-G6-20			548074	DYSW-10-17-Y1F	
	25	DADP-ES-G6-25			548075	DYSW-12-20-Y1F	
Reducing sleeve DAYH Data sheets → Internet: dayh							
	10	–	For DYSW-4-6	–	1165476	DAYH-4	1
	12	DADP-ES-G6-12	For DYSW-5-8		1165480	DAYH-5	
	16	DADP-ES-G6-16	For DYSW-7-10		1165484	DAYH-7	
	20	DADP-ES-G6-20	For DYSW-8-14		1165488	DAYH-8	
	25	DADP-ES-G6-25	For DYSW-10-17		1165491	DAYH-10	

1) Packaging unit

Accessories

Ordering data					
	For size	Description	Part no.	Type	PU ¹⁾
Centring sleeve ZBH Data sheets → Internet: zbh					
	4, 6	For centring loads and attachments (6 centring sleeves are included in the scope of delivery of the mini slide)	189652	ZBH-5	10
	8, 10, 12, 16		186717	ZBH-7	
	20, 25		8137184	ZBH-9-B	
Connector sleeve ZBV Data sheets → Internet: zbv					
	8, 10	<ul style="list-style-type: none"> For connecting two mini slides DGSL Sizing information refers to the y axis 	548802	ZBV-M4-7	3
	12, 16		548803	ZBV-M5-7	
	20, 25		548804	ZBV-M6-9	



1) Packaging unit

Ordering data					
	For size	Description	Part no.	Type	PU ¹⁾
One-way flow control valve GRLA Data sheets → Internet: grla					
	4, 6, 8	<ul style="list-style-type: none"> For regulating speed Only one GRLA-M3-QS-3 can be mounted on the front with size 4 	175041	GRLA-M3-QS-3	1
	10, 12, 16		175038	GRLA-M3	
			★ 193137	GRLA-M5-QS-3-D	
	20, 25		★ 193138	GRLA-M5-QS-4-D	
	20, 25	★ 193143	GRLA-1/8-QS-4-D		
		★ 193144	GRLA-1/8-QS-6-D		
		162965	GRLA-1/8-QS-6-RS-B		
		162966	GRLA-1/8-QS-8-RS-B		
Push-in fitting QSM Data sheets → Internet: qs					
	4, 6, 8	For connecting tubing with standard O.D.	★ 153301	QSM-M3-3	10
	10, 12, 16		★ 153304	QSM-M5-4	
	20, 25		★ 153307	QSM-1/8-6	

1) Packaging unit



Accessories



Proximity switch for mini slide DGSL and intermediate-position module DADM-EP-G6-10						
Ordering data – Proximity switch for C-slot, magneto-resistive						
	Type of mounting	Switching output	Electrical connection, outlet direction of connection	Cable length [m]	Part no.	Type
Data sheets → Internet: smt						
N/O						
	Inserted in the slot from above	PNP	Cable, 3-wire, in-line	2.5	★ 551373	SMT-10M-PS-24V-E-2.5-L-OE
			Plug M8x1, 3-pin, in-line	0.3	★ 551375	SMT-10M-PS-24V-E-0.3-L-M8D
			Plug M8x1, 3-pin, lateral	0.3	551376	SMT-10M-PS-24V-E-0.3-Q-M8D

Ordering data – Proximity switch for C-slot, magnetic reed ¹⁾						
	Type of mounting	Switching output	Electrical connection, outlet direction of connection	Cable length [m]	Part no.	Type
Data sheets → Internet: sme						
N/O						
	Inserted in the slot from above	Contacting	Plug M8x1, 3-pin, in-line	0.3	★ 551367	SME-10M-DS-24V-E-0.3-L-M8D
			Cable, 3-wire, in-line	2.5	★ 551365	SME-10M-DS-24V-E-2.5-L-OE
			Cable, 2-wire, in-line	2.5	★ 551369	SME-10M-ZS-24V-E-2.5-L-OE
	Inserted in the slot lengthwise	Contacting	Plug M8x1, 3-pin, in-line	0.3	173212	SME-10-SL-LED-24
			Cable, 3-wire, in-line	2.5	173210	SME-10-KL-LED-24

1) Proximity switches are not permitted on the mini-slide DGSL-4.

Proximity switch for intermediate-position module DADM-EP-G6-16						
Ordering data – Proximity switch for T-slot, magneto-resistive						
	Type of mounting	Switching output	Electrical connection	Cable length [m]	Part no.	Type
Data sheets → Internet: smt						
N/O						
	Inserted in the slot from above, flush with the cylinder profile, short design	PNP	Cable, 3-wire	2.5	★ 574335	SMT-8M-A-PS-24V-E-2.5-OE
			Plug M8x1, 3-pin	0.3	★ 574334	SMT-8M-A-PS-24V-E-0.3-M8D
			Plug M12x1, 3-pin	0.3	★ 574337	SMT-8M-A-PS-24V-E-0.3-M12
		NPN	Cable, 3-wire	2.5	★ 574338	SMT-8M-A-NS-24V-E-2.5-OE
			Plug M8x1, 3-pin	0.3	★ 574339	SMT-8M-A-NS-24V-E-0.3-M8D

Ordering data – Proximity switch for T-slot, magnetic reed						
	Type of mounting	Switching output	Electrical connection	Cable length [m]	Part no.	Type
Data sheets → Internet: sme						
N/O						
	Inserted in the slot from above, flush with the cylinder profile	Contacting	Cable, 3-wire	2.5	★ 543862	SME-8M-DS-24V-K-2.5-OE
			Cable, 3-wire	5.0	★ 543863	SME-8M-DS-24V-K-5.0-OE
			Cable, 2-wire	2.5	★ 543872	SME-8M-ZS-24V-K-2.5-OE
			Plug M8x1, 3-pin	0.3	★ 543861	SME-8M-DS-24V-K-0.3-M8D
				Inserted in the slot lengthwise, flush with the cylinder profile	Contacting	Cable, 3-wire
Plug M8x1, 3-pin	0.3	150857				SME-8-S-LED-24

Ordering data – Connecting cables						
	Electrical connection, left	Electrical connection, right	Cable length [m]	Part no.	Type	
Data sheets → Internet: nebu						
	Straight socket, M8x1, 3-pin	Cable, open end, 3-wire	2.5	★ 541333	NEBU-M8G3-K-2.5-LE3	
			5	★ 541334	NEBU-M8G3-K-5-LE3	
	Angled socket, M8x1, 3-pin	Cable, open end, 3-wire	2.5	★ 541338	NEBU-M8W3-K-2.5-LE3	
			5	★ 541341	NEBU-M8W3-K-5-LE3	

Accessories

Adapter kit

Material:
Wrought aluminium alloy
Free of copper and PTFE
RoHS-compliant

 - **Note**
The kit includes the individual mounting interface as well as the necessary mounting material.

Permissible drive/drive combinations with adapter kit

Download CAD data → www.festo.com

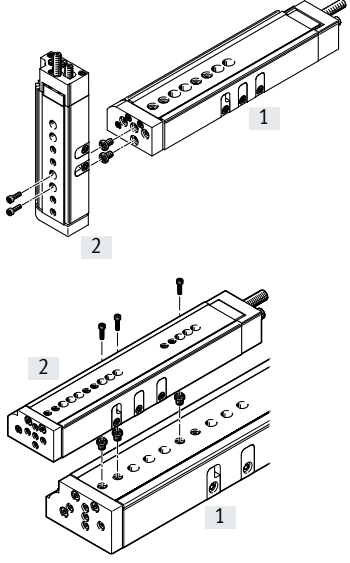
Combination	[1] Drive Size	[2] Drive Size	Adapter kit		Quantity required	PU ²⁾	
			CRC ¹⁾	Part no.			
DGSL/DGSL	DGSL	DGSL					
	4	4	2	-	M3x7 DIN 912 ³⁾	2	-
				189652	ZBH-5 ⁴⁾	2	10
	6	4, 6		-	M3x10 DIN 912 ³⁾	2	-
				189652	ZBH-5 ⁴⁾	2	10
	8, 10	4, 6		548802	ZBV-M4-7	1	3
	8, 10	8		-	M4x12 DIN 912 ³⁾	2	-
				186717	ZBH-7 ⁴⁾	2	10
	10	10		-	M4x14 DIN 912 ³⁾	2	-
				186717	ZBH-7 ⁴⁾	2	10
	12, 16	8, 10		548803	ZBV-M5-7	1	3
	12	12		-	M5x14 DIN 912 ³⁾	2	-
				186717	ZBH-7 ⁴⁾	2	10
	16	12		-	M5x16 DIN 912 ³⁾	2	-
				186717	ZBH-7 ⁴⁾	2	10
	16	16		-	M5x18 DIN 912 ³⁾	2	-
				186717	ZBH-7 ⁴⁾	2	10
20, 25	12, 16	548804	ZBV-M6-9	1	3		
20, 25	20	-	M6x20 DIN 912 ³⁾	2	-		
		8137184	ZBH-9-B ⁴⁾	2	10		
25	25	-	M6x30 DIN 912 ³⁾	2	-		
		8137184	ZBH-9-B ⁴⁾	2	10		

1) Corrosion resistance class CRC 2 to Festo standard FN 940070

Moderate corrosion stress. Indoor applications in which condensation can occur. External visible parts with primarily decorative surface requirements which are in direct contact with a normal industrial environment.

2) Packaging unit.

3) The screws listed are not included in the scope of delivery of the drives.

4) The centring sleeves are included in the scope of delivery of the drives.

Accessories

Adapter kit
HAPS, HMSV

Material:
Wrought aluminium alloy
Free of copper and PTFE
RoHS-compliant

**Note**

The kit includes the individual mounting interface as well as the necessary mounting material.

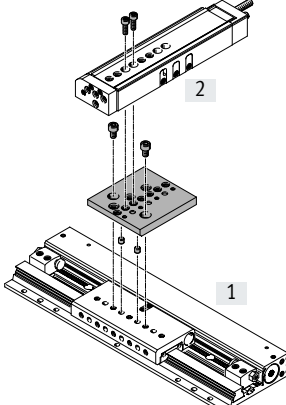
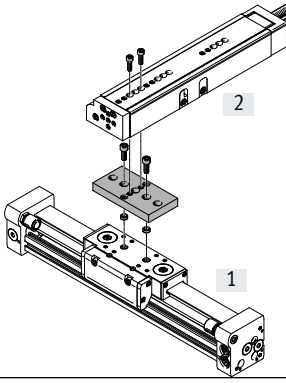
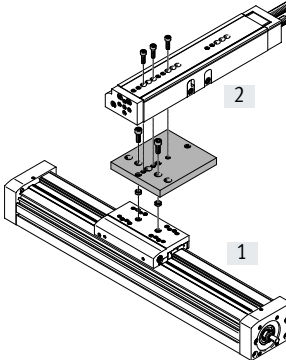
Permissible drive/drive combinations with adapter kit							Download CAD data → www.festo.com	
Combination	[1] Drive Size	[2] Drive Size	Adapter kit CRC ¹⁾	Part no.	Type	Quantity required	PU ²⁾	
	SLG	DGSL	HAPS					
	8, 12	4, 6	2	189533	HAPS-11	1	1	
	12	8, 10		189534	HAPS-12	1	1	
	18	8, 10, 12						
	DGC	DGSL	HMSV					
	8, 12	4, 6	2	548777	HMSV-47	1	1	
	18	8, 10		548778	HMSV-48	1	1	
	18	12, 16		189657	HMSV-41	1	1	
	25	12, 16, 20, 25		548781	HMSV-51	1	1	
	32, 40	20, 25		548780	HMSV-50	1	1	
	DGE	DGSL	HMSV					
	25	12, 16, 20, 25	2	548781	HMSV-51	1	1	
	40	20, 25		548780	HMSV-50	1	1	

1) Corrosion resistance class CRC 2 to Festo standard FN 940070

Moderate corrosion stress. Indoor applications in which condensation can occur. External visible parts with primarily decorative surface requirements which are in direct contact with a normal industrial environment.

2) Packaging unit.

Accessories

Adapter kit
HMSV, DHAA

Material:
Wrought aluminium alloy
Free of copper and PTFE
RoHS-compliant

 **Note**
The kit includes the individual mounting interface as well as the necessary mounting material.

Permissible drive/drive combinations with adapter kit

Download CAD data → www.festo.com

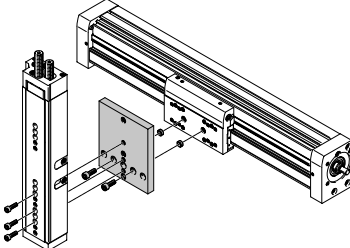
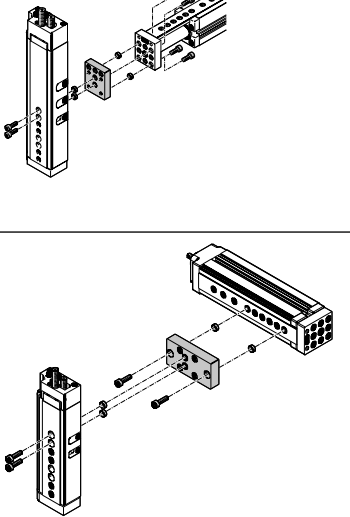
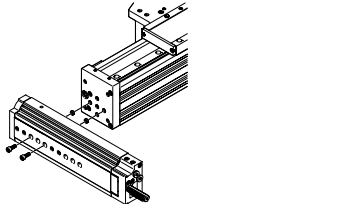
Combination	[1] Drive Size	[2] Drive Size	Adapter kit CRC ¹⁾	Part no.	Type	Quantity required	PU ²⁾	
EGC/DGSL	EGC	DGSL	HMSV					
	50	4, 6	2	548777	HMSV-47	1	1	
	70	8, 10		548778	HMSV-48	1	1	
	70	12, 16		189657	HMSV-41	1	1	
	80	12, 16, 20, 25		548781	HMSV-51	1	1	
	120	20, 25		548780	HMSV-50	1	1	
EGSL/DGSL	EGSL	DGSL	HMSV					
	35	4, 6, 8, 10	2	1088262	HMSV-70	1	–	
	45, 55	8, 10		548803	ZBV-M5-7	1	3	
	45	12, 16		–	M5x14 DIN 912 ³⁾	2	–	
	55	12, 16		186717	ZBH-7 ⁴⁾	2	10	
				–	M5x12 DIN 912 ³⁾	2	–	
	75	12, 16		186717	ZBH-7 ⁴⁾	2	10	
	75	20		548804	ZBV-M6-9	1	3	
				–	M6x20 DIN 912 ³⁾	2	–	
	35	4, 6, 8, 10		2	8137184	ZBH-9-B ⁴⁾	2	10
					1088327	HMSV-73	1	–
ELCC/DGSL	ELCC	DGSL	DHAA					
	60	8-50	2	5)	–	–		
	60	10-50		5)	–	–		
	70	12-80		5)	–	–		
	70	16-80		5)	–	–		
	90, 110	20-150		5)	–	–		
	90, 110	25-150		5)	–	–		

- 1) Corrosion resistance class CRC 2 to Festo standard FN 940070
Moderate corrosion stress. Indoor applications in which condensation can occur. External visible parts with primarily decorative surface requirements which are in direct contact with a normal industrial environment.
- 2) Packaging unit.
- 3) The screws listed are not included in the scope of delivery of the drives.
- 4) The centring sleeves are included in the scope of delivery of the drives.
- 5) No adapter kit required as direct mounting is possible