







Branching modules/Distributor blocks MS-FRM, MS series

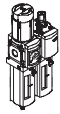
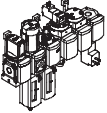

# Branching modules/Distributor blocks MS-FRM, MS series

FESTO

Product range overview – MS series service units

Type	Size	Pneumatic connection in housing	Connecting plate	Pressure regulation range [bar]						Grade of filtration [µm]			
				0.05	0.05	0.1	0.3	0.1	0.5				
				...	...	...	...	...	...	0.01	1	5	40
Code			AG...	D2	D4	D5	D6	D7	D8	A	B	C	E
<b>Service units</b>													
<b>MSB-FRC</b> 	4	G1/8, G1/4	G1/8, G1/4, G3/8	-	-	-	■	■	-	-	-	■	■
	6	G1/4, G3/8, G1/2	G1/4, G3/8, G1/2, G3/4	-	-	-	■	■	-	-	-	■	■
	9	-											
	12	-											
<b>Service unit combinations (further variants can be ordered using the configurator → Internet: msb4, msb6 or msb9)</b>													
<b>MSB</b> 	4	G1/4	G1/8, G1/4, G3/8	-	-	-	■	■	-	-	-	■	■
	6	G1/2	G1/4, G3/8, G1/2, G3/4	-	-	-	■	■	-	-	-	■	■
	9	-											
	12	-											
<b>Individual devices</b>													
Filter regulators <b>MS-LFR</b> 	4	G1/8, G1/4	G1/8, G1/4, G3/8	-	-	■	■	■	-	-	-	■	■
	6	G1/4, G3/8, G1/2	G1/4, G3/8, G1/2, G3/4	-	-	■	■	■	■	-	-	■	■
	9	-											
	12	-	G1, G1 1/4, G1 1/2, G2	-	-	-	■	■	■	-	-	■	■
Filters <b>MS-LF</b> 	4	G1/8, G1/4	G1/8, G1/4, G3/8	-	-	-	-	-	-	-	-	■	■
	6	G1/4, G3/8, G1/2	G1/4, G3/8, G1/2, G3/4	-	-	-	-	-	-	-	-	■	■
	9	-											
	12	-	G1, G1 1/4, G1 1/2, G2	-	-	-	-	-	-	-	-	■	■
Fine and micro filters <b>MS-LFM</b> 	4	G1/8, G1/4	G1/8, G1/4, G3/8	-	-	-	-	-	-	■	■	-	-
	6	G1/4, G3/8, G1/2	G1/4, G3/8, G1/2, G3/4	-	-	-	-	-	-	■	■	-	-
	9	G3/4, G1	G1/2, G3/4, G1, G1 1/4, G1 1/2	-	-	-	-	-	-	■	■	-	-
	12	-	G1, G1 1/4, G1 1/2, G2	-	-	-	-	-	-	■	■	-	-
Activated carbon filters <b>MS-LFX</b> 	4	G1/8, G1/4	G1/8, G1/4, G3/8	-	-	-	-	-	-	-	-	-	-
	6	G1/4, G3/8, G1/2	G1/4, G3/8, G1/2, G3/4	-	-	-	-	-	-	-	-	-	-
	9	G3/4, G1	G1/2, G3/4, G1, G1 1/4, G1 1/2	-	-	-	-	-	-	-	-	-	-
	12	-	G1, G1 1/4, G1 1/2, G2	-	-	-	-	-	-	-	-	-	-
Water separators <b>MS-LWS</b> 	4	-											
	6	G1/4, G3/8, G1/2	G1/4, G3/8, G1/2, G3/4	-	-	-	-	-	-	-	-	-	-
	9	-											
	12	-											

# Branching modules/Distributor blocks MS-FRM, MS series

Product range overview – MS series service units

Type	Size	Bowl guard		Condensate drains				Pressure indicator					Security		Options		→ Page/ Internet
		Plastic bowl with plastic bowl guard	Metal bowl	Manual rotary	Semi-automatic	Fully automatic	External, fully automatic, electrical	Cover plate (without pressure gauge)	Integrated MS pressure gauge	Adapter plate for EN pressure gauge G1/8	Adapter plate for EN pressure gauge G1/4	Pressure sensor	Rotary knob with detent, lockable via accessories	Rotary knob with integrated lock	Silencer	Flow direction from right to left	
Code		R	U	M	H	V	E...	VS	AG	A8	A4	AD...	AS	E11	S	Z	
<b>Service units</b>																	
MSB-FRC	4	■	-	■	-	■	-	-	■	-	-	-	■	-	-	■	msb4
	6	■	■	■	-	■	-	-	■	-	-	-	■	-	-	■	msb6
	9	-	-	-	-	-	-	-	-	-	-	-	-	-	-	-	-
	12	-	-	-	-	-	-	-	-	-	-	-	-	-	-	-	-
<b>Service unit combinations</b>																	
MSB	4	■	■	■	-	■	-	-	■	-	-	-	■	-	-	■	msb4
	6	■	■	■	-	■	-	-	■	-	-	-	■	-	-	■	msb6
	9	-	-	-	-	-	-	-	-	-	-	-	-	-	-	-	-
	12	-	-	-	-	-	-	-	-	-	-	-	-	-	-	-	-
<b>Individual devices</b>																	
Filter regulators MS-LFR	4	■	■	■	■	■	-	■	■	■	■	■	■	■	-	■	ms4-lfr
	6	■	■	■	■	■	■	■	■	-	■	■	■	■	-	■	ms6-lfr
	9	-	-	-	-	-	-	-	-	-	-	-	-	-	-	-	-
	12	-	■	■	-	■	■	■	■	-	■	-	■	■	-	■	ms12-lfr
Filters MS-LF	4	■	■	■	■	■	-	-	-	-	-	-	-	-	-	■	ms4-lf
	6	■	■	■	■	■	■	-	-	-	-	-	-	-	-	■	ms6-lf
	9	-	-	-	-	-	-	-	-	-	-	-	-	-	-	-	-
	12	-	■	■	-	■	■	-	-	-	-	-	-	-	-	■	ms12-lf
Fine and micro filters MS-LFM	4	■	■	■	■	■	-	-	-	-	-	-	-	-	-	■	ms4-lfm
	6	■	■	■	■	■	■	-	-	-	-	-	-	-	-	■	ms6-lfm
	9	-	■	■	-	■	■	-	-	-	-	-	-	-	-	■	ms9-lfm
	12	-	■	■	-	■	■	-	-	-	-	-	-	-	-	■	ms12-lfm
Activated carbon filters MS-LFX	4	■	■	-	-	-	-	-	-	-	-	-	-	-	-	■	ms4-lfx
	6	■	■	-	-	-	-	-	-	-	-	-	-	-	-	■	ms6-lfx
	9	-	■	-	-	-	-	-	-	-	-	-	-	-	-	■	ms9-lfx
	12	-	■	-	-	-	-	-	-	-	-	-	-	-	-	■	ms12-lfx
Water separators MS-LWS	4	-	-	-	-	-	-	-	-	-	-	-	-	-	-	-	-
	6	-	■	-	-	■	■	-	-	-	-	-	-	-	-	■	ms6-lws
	9	-	-	-	-	-	-	-	-	-	-	-	-	-	-	-	-
	12	-	-	-	-	-	-	-	-	-	-	-	-	-	-	-	-

# Branching modules/Distributor blocks MS-FRM, MS series



Product range overview – MS series service units

Type	Size	Pneumatic connection in housing	Connecting plate	Pressure regulation range [bar]						Supply voltage			
				0.05 ... 0.7	0.05 ... 2.5	0.1 ... 4	0.3 ... 7	0.1 ... 12	0.5 ... 16	24 V DC, connection pattern to EN 175301	24 V DC, connection pattern M12 to DESINA	110 V AC, connection pattern to EN 175301	230 V AC, connection pattern to EN 175301
Code			AG...	D2	D4	D5	D6	D7	D8	V24	V24P	V110	V230
<b>Individual devices</b>													
Pressure regulators <b>MS-LR</b>		4	G1/8, G1/4	G1/8, G1/4, G3/8	-	-	■	■	■	-	-	-	-
		6	G1/4, G3/8, G1/2	G1/4, G3/8, G1/2, G3/4	-	-	■	■	■	■	-	-	-
		9	-										
		12	-	G1, G1 1/4, G1 1/2, G2	-	-	-	■	■	■	-	-	-
Pressure regulators <b>MS-LRB</b>		4	G1/4	G1/8, G1/4, G3/8	-	-	■	■	■	-	-	-	-
		6	G1/2	G1/4, G3/8, G1/2, G3/4	-	-	■	■	■	■	-	-	-
		9	-										
		12	-										
Precision pressure regulators <b>MS-LRP</b>		4	-										
		6	G1/4, G3/8, G1/2	G1/4, G3/8, G1/2, G3/4	■	■	■	-	■	-	-	-	-
		9	-										
		12	-										
Precision pressure regulators <b>MS-LRPB</b>		4	-										
		6	G1/2	G1/4, G3/8, G1/2, G3/4	■	■	■	-	■	-	-	-	-
		9	-										
		12	-										
Electrical pressure regulators <b>MS-LRE</b>		4	-										
		6	G1/4, G3/8, G1/2	G1/4, G3/8, G1/2, G3/4	-	-	■	■	■	■	-	-	-
		9	-										
		12	-										
Lubricators <b>MS-LOE</b>		4	G1/8, G1/4	G1/8, G1/4, G3/8	-	-	-	-	-	-	-	-	-
		6	G1/4, G3/8, G1/2	G1/4, G3/8, G1/2, G3/4	-	-	-	-	-	-	-	-	-
		9	-										
		12	-	G1, G1 1/4, G1 1/2, G2	-	-	-	-	-	-	-	-	-
Electrical on-off valves <b>MS-EM(1)</b>		4	G1/8, G1/4	G1/8, G1/4, G3/8	-	-	-	-	-	-	-	-	-
		6	G1/4, G3/8, G1/2	G1/4, G3/8, G1/2, G3/4	-	-	-	-	-	-	-	-	-
		9	-										
		12	-	G1, G1 1/4, G1 1/2, G2	-	-	-	-	-	-	-	-	-
Electrical on-off valves <b>MS-EE</b>		4	G1/8, G1/4	G1/8, G1/4, G3/8	-	-	-	-	-	-	■	-	■
		6	G1/4, G3/8, G1/2	G1/4, G3/8, G1/2, G3/4	-	-	-	-	-	-	■	-	■
		9	-										
		12	-	G1, G1 1/4, G1 1/2, G2	-	-	-	-	-	-	■	■	■
Electrical soft-start valves <b>MS-DL</b>		4	G1/8, G1/4	G1/8, G1/4, G3/8	-	-	-	-	-	-	-	-	-
		6	G1/4, G3/8, G1/2	G1/4, G3/8, G1/2, G3/4	-	-	-	-	-	-	-	-	-
		9	-										
		12	-	G1, G1 1/4, G1 1/2, G2	-	-	-	-	-	-	-	-	-
Electrical soft-start valves <b>MS-DE</b>		4	G1/8, G1/4	G1/8, G1/4, G3/8	-	-	-	-	-	-	■	-	■
		6	G1/4, G3/8, G1/2	G1/4, G3/8, G1/2, G3/4	-	-	-	-	-	-	■	-	■
		9	-										
		12	-	G1, G1 1/4, G1 1/2, G2	-	-	-	-	-	-	■	■	■
Soft start and exhaust valves <b>MS-SV</b>		4	-										
		6	G1/2	G1/4, G3/8, G1/2, G3/4	-	-	-	-	-	-	■	-	-
		9	-										
		12	-										





# Branching modules/Distributor blocks MS-FRM, MS series

Product range overview – MS series service units

Type	Size	Bowl guard		Pressure indicator				Security		Options		→ Page/ Internet	
		Plastic bowl with plastic bowl guard	Metal bowl	Cover plate (without pressure gauge)	Integrated MS pressure gauge	Adapter plate for EN pressure gauge G1/8	Adapter plate for EN pressure gauge G1/4	Pressure sensor	Rotary knob with detent, lockable via accessories	Rotary knob with integrated lock	Silencer		Flow direction from right to left
Code		R	U	VS	AG	A8	A4	AD...	AS	E11	S	Z	
<b>Individual devices</b>													
Pressure regulators <b>MS-LR</b>	4	-	-	■	■	■	■	■	■	■	-	■	ms4-lr
	6	-	-	■	■	-	■	■	■	■	-	■	ms6-lr
	9	-	-	-	-	-	-	-	-	-	-	-	-
	12	-	-	■	■	-	■	-	■	■	-	■	ms12-lr
Pressure regulators <b>MS-LRB</b>	4	-	-	■	■	■	■	■	■	■	-	■	ms4-lrb
	6	-	-	■	■	-	■	■	■	■	-	■	ms6-lrb
	9	-	-	-	-	-	-	-	-	-	-	-	-
	12	-	-	-	-	-	-	-	-	-	-	-	-
Precision pressure regulators <b>MS-LRP</b>	4	-	-	-	-	-	-	-	-	-	-	-	-
	6	-	-	■	-	■	■	■	■	■	-	■	ms6-lrp
	9	-	-	-	-	-	-	-	-	-	-	-	-
	12	-	-	-	-	-	-	-	-	-	-	-	-
Precision pressure regulators <b>MS-LRPB</b>	4	-	-	-	-	-	-	-	-	-	-	-	-
	6	-	-	■	-	■	■	■	■	■	-	■	ms6-lrpb
	9	-	-	-	-	-	-	-	-	-	-	-	-
	12	-	-	-	-	-	-	-	-	-	-	-	-
Electrical pressure regulators <b>MS-LRE</b>	4	-	-	-	-	-	-	-	-	-	-	-	-
	6	-	-	■	■	-	■	-	-	-	-	■	ms6-lre
	9	-	-	-	-	-	-	-	-	-	-	-	-
	12	-	-	-	-	-	-	-	-	-	-	-	-
Lubricators <b>MS-LOE</b>	4	■	■	-	-	-	-	-	-	-	-	■	ms4-loe
	6	■	■	-	-	-	-	-	-	-	-	■	ms6-loe
	9	-	-	-	-	-	-	-	-	-	-	-	-
	12	-	■	-	-	-	-	-	-	-	-	■	ms12-loe
Electrical on-off valves <b>MS-EM(1)</b>	4	-	-	■	■	■	■	■	-	-	■	■	ms4-em1
	6	-	-	■	■	-	■	■	-	-	■	■	ms6-em1
	9	-	-	-	-	-	-	-	-	-	-	-	-
	12	-	-	■	■	-	■	-	-	-	■	■	ms12-em
Electrical on-off valves <b>MS-EE</b>	4	-	-	■	■	■	■	■	-	-	■	■	ms4-ee
	6	-	-	■	■	-	■	■	-	-	■	■	ms6-ee
	9	-	-	-	-	-	-	-	-	-	-	-	-
	12	-	-	■	■	-	■	-	-	-	■	■	ms12-ee
Electrical soft-start valves <b>MS-DL</b>	4	-	-	■	■	■	■	■	-	-	-	■	ms4-dl
	6	-	-	■	■	-	■	■	-	-	-	■	ms6-dl
	9	-	-	-	-	-	-	-	-	-	-	-	-
	12	-	-	■	■	-	■	-	-	-	-	■	ms12-dl
Electrical soft-start valves <b>MS-DE</b>	4	-	-	■	■	■	■	■	-	-	-	■	ms4-de
	6	-	-	■	■	-	■	■	-	-	-	■	ms6-de
	9	-	-	-	-	-	-	-	-	-	-	-	-
	12	-	-	■	■	-	■	-	-	-	-	■	ms12-de
Soft start and exhaust valves <b>MS-SV</b>	4	-	-	-	-	-	-	-	-	-	-	-	-
	6	-	-	■	■	-	■	■	-	-	■	■	ms6-sv
	9	-	-	-	-	-	-	-	-	-	-	-	-
	12	-	-	-	-	-	-	-	-	-	-	-	-

# Branching modules/Distributor blocks MS-FRM, MS series

Product range overview – MS series service units

Type	Size	Pneumatic connection in housing	Connecting plate	Pressure regulation range [bar]				Supply voltage				
				0.1 ... 4	0.3 ... 7	0.1 ... 12	0.5 ... 16	24 V DC, connection pattern to EN 175301	24 V DC, connection pattern M12 to DESINA	110 V AC, connection pattern to EN 175301	230 V AC, connection pattern to EN 175301	
Code			AG...	D5	D6	D7	D8	V24	V24P	V110	V230	
<b>Individual devices</b>												
Membrane air dryers <b>MS-LDM1</b>		4	G1/8, G1/4	G1/8, G1/4, G3/8	-	-	-	-	-	-	-	-
		6	G1/4, G3/8, G1/2	G1/4, G3/8, G1/2, G3/4	-	-	-	-	-	-	-	-
		9	-	-	-	-	-	-	-	-	-	-
		12	-	-	-	-	-	-	-	-	-	-
Branching modules <b>MS-FRM</b>		4	G1/8, G1/4	G1/8, G1/4, G3/8	-	-	-	-	-	-	-	-
		6	G1/4, G3/8, G1/2	G1/4, G3/8, G1/2, G3/4	-	-	-	-	-	-	-	-
		9	-	-	-	-	-	-	-	-	-	-
		12	-	G1, G1 1/4, G1 1/2, G2	-	-	-	-	-	-	-	-
Distributor blocks <b>MS-FRM-FRZ</b>		4	G1/4	-	-	-	-	-	-	-	-	-
		6	G1/2	-	-	-	-	-	-	-	-	-
		9	-	-	-	-	-	-	-	-	-	-
		12	-	-	-	-	-	-	-	-	-	-
Flow sensors <b>MS-SFE</b>		4	-	-	-	-	-	-	-	-	-	-
		6	G1/2	G1/2	-	-	-	-	-	-	-	-
		9	-	-	-	-	-	-	-	-	-	-
		12	-	-	-	-	-	-	-	-	-	-
Flow sensors <b>SFAM</b>		4	-	-	-	-	-	-	-	-	-	-
		6	G1/2	G1/2	-	-	-	-	-	-	-	-
		9	-	-	-	-	-	-	-	-	-	-
		12	-	-	-	-	-	-	-	-	-	-

# Branching modules/Distributor blocks MS-FRM, MS series

Product range overview – MS series service units

Type	Size	Bowl guard		Pressure indicator				Switch output		Options		→ Page/ Internet	
		Plastic bowl with plastic bowl guard	Metal bowl	Cover plate (without pressure gauge)	Integrated MS pressure gauge	Adapter plate for EN pressure gauge G1/8	Adapter plate for EN pressure gauge G1/4	Pressure sensor	2x PNP	2x NPN	Silencer		Flow direction from right to left
Code		R	U	VS	AG	A8	A4	AD...	P2/2S	N2/2S	S	Z/R	
<b>Individual devices</b>													
Membrane air dryers <b>MS-LDM1</b>	4	-	■	-	-	-	-	-	-	-	-	■	ms4-ldm1
	6	-	■	-	-	-	-	-	-	-	-	■	ms6-ldm1
	9	-	-	-	-	-	-	-	-	-	-	-	-
	12	-	-	-	-	-	-	-	-	-	-	-	-
Branching modules <b>MS-FRM</b>	4	-	-	■	■	■	■	■	-	-	-	■	8
	6	-	-	■	■	-	■	■	-	-	-	■	8
	9	-	-	-	-	-	-	-	-	-	-	-	-
	12	-	-	■	-	-	-	-	-	-	-	-	20
Distributor blocks <b>MS-FRM-FRZ</b>	4	-	-	-	-	-	-	-	-	-	-	■	18
	6	-	-	-	-	-	-	-	-	-	-	■	18
	9	-	-	-	-	-	-	-	-	-	-	-	-
	12	-	-	-	-	-	-	-	-	-	-	-	-
Flow sensors <b>MS-SFE</b>	4	-	-	-	-	-	-	-	-	-	-	-	-
	6	-	-	-	-	-	-	-	■	■	-	■ <sup>1)</sup>	ms6-sfe
	9	-	-	-	-	-	-	-	-	-	-	-	-
	12	-	-	-	-	-	-	-	-	-	-	-	-
Flow sensors <b>SFAM</b>	4	-	-	-	-	-	-	-	-	-	-	-	-
	6	-	-	-	-	-	-	-	■	■	-	■	sfam
	9	-	-	-	-	-	-	-	-	-	-	-	-
	12	-	-	-	-	-	-	-	-	-	-	-	-

1) Can only be ordered using the configurator → Internet: ms6-sfe

## Branching modules MS4/MS6-FRM, MS series

Peripherals overview

### Branching module MS4/MS6-FRM

 Note

Additional accessories:

- Module connector for combination with size MS4/MS6 or size MS9 → Internet: amv, rmv, armv
- Adapter plate for mounting on profiles → Internet: ipm-80, ipm-40-80, ipm-80-80

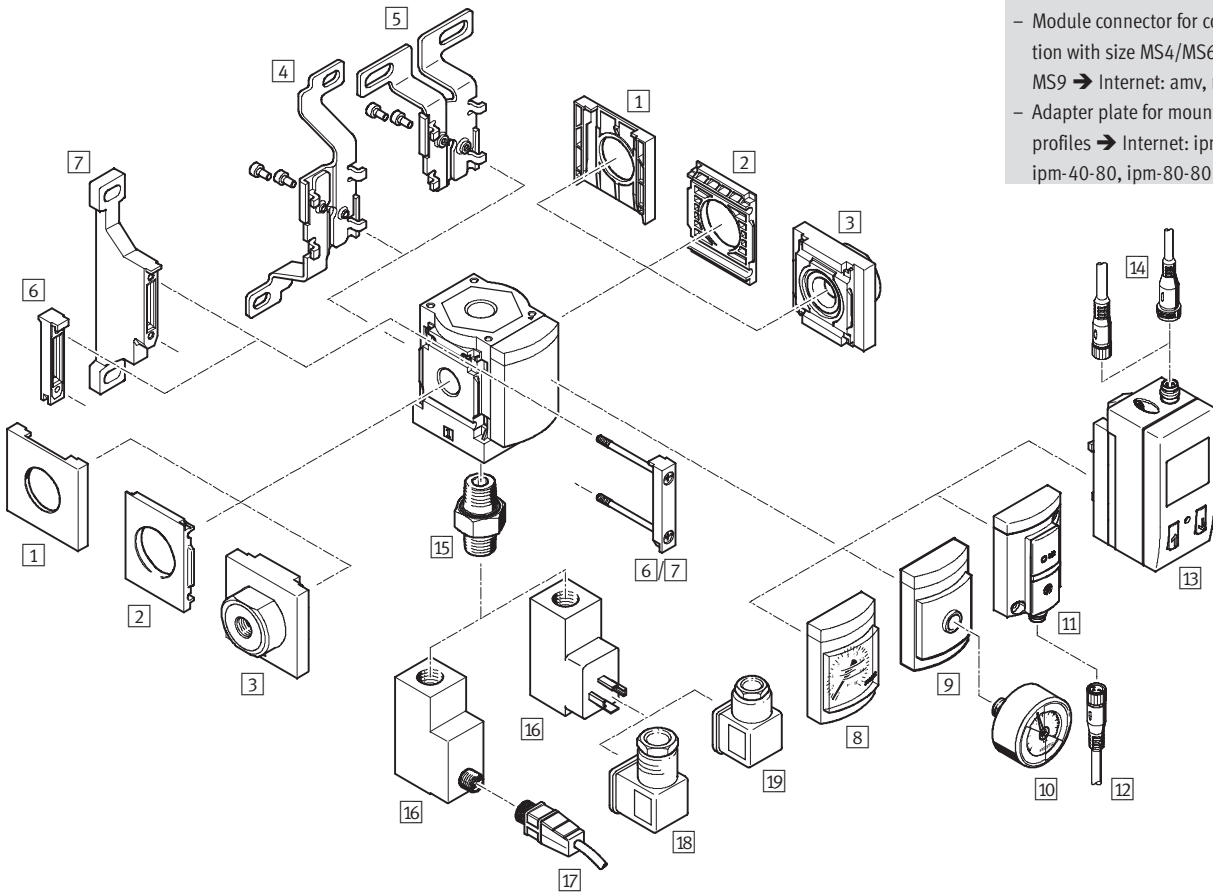



## Branching modules MS4/MS6-FRM, MS series

Peripherals overview

Mounting attachments and accessories						
		Individual device		Combination		→ Page/Internet
		Without connecting plate	With connecting plate	Without connecting plate	With connecting plate	
1	Cover cap MS4/6-END	■	–	■	–	ms4-end, ms6-end
2	Mounting plate MS4/6-AEND	■ <sup>1)</sup>	–	■ <sup>1)</sup>	–	ms4-aend, ms6-aend
3	Connecting plate MS4/6-AG...	–	■ <sup>1)</sup>	–	■ <sup>1)</sup>	ms4-ag, ms6-ag
4	Mounting bracket MS4/6-WB	■	■	–	–	ms4-wb, ms6-wb
5	Mounting bracket MS4-WBM	■	■	–	–	ms4-wbm
6	Module connector MS4/6-MV	–	■	■	■	ms4-mv, ms6-mv
7	Mounting bracket MS4/6-WP	■	■	■	■	ms4-wp, ms6-wp
	Mounting bracket (not illustrated) MS4/6-WPB/WPE/WPM	■	■	■	■	ms4-wp, ms6-wp
8	MS pressure gauge AG	■	■	■	■	16
9	Adapter plate for EN pressure gauge 1/8/1/4 A8/A4	■	■	■	■	16
10	Pressure gauge MA	■	■	■	■	25
11	Pressure sensor without display AD7 ... AD10	■	■	■	■	16
12	Connecting cable NEBU-M8...-LE3	■	■	■	■	25
13	Pressure sensor with display AD1 ... AD4	■	■	■	■	16
14	Connecting cable NEBU-M8...-LE3/NEBU-M12...-LE4	■	■	■	■	25
15	Double nipple ESK	■	■	■	■	26
16	Pressure switch PEV X/Y/M12	■	■	■	■	16
17	Connecting cable NEBU-M12...-LE4	■	■	■	■	25
18	Angled socket PEV-1/4-WD-LED-...	■	■	■	■	26
19	Plug socket MSSD-C-4P	■	■	■	■	26

1) Module connector MS4/6-MV [6] or mounting bracket MS4/6-WP/WPB/WPE/WPM [7] is required for mounting.

## Branching modules MS4/MS6-FRM, MS series

Type codes

Series		MS	4	-	FRM	-	1/8	-	Y
MS	Standard service unit								
Size									
4	Grid dimension 40 mm								
6	Grid dimension 62 mm								
Service function									
FRM	Branching module								
Connection size									
MS4									
1/8	Thread G1/8								
1/4	Thread G1/4								
MS6									
1/4	Thread G1/4								
3/8	Thread G3/8								
1/2	Thread G1/2								
Non-return function/pressure switch									
	Standard								
I	With integrated non-return function								
Y	With pressure switch								

Further variants can be ordered using the modular system → 16

- Connecting plates
- Pressure gauge alternatives
- Alternative pressure gauge scale
- Pressure switch
- Type of mounting
- Alternative flow direction

## Branching modules MS4/MS6-FRM, MS series

**FESTO**

Technical data

Function  
Standard



With integrated non-return function

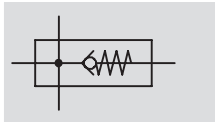

 - Flow rate  
1,200 ... 14,700 l/min

 - Temperature range  
-10 ... +60 °C

 - Operating pressure  
0 ... 20 bar



- Pneumatic manifold with 4 connections
- Can be used as an intermediate distributor for varying air qualities
- Attachment facility for auxiliary modules
- Outlet top and bottom
- An integrated non-return valve prevents the return flow e.g. of lubricated compressed air
- Optional pressure sensor

General technical data					
Size	MS4		MS6		
Pneumatic connection 1, 2	G $\frac{1}{8}$	G $\frac{1}{4}$	G $\frac{1}{4}$	G $\frac{3}{8}$	G $\frac{1}{2}$
Pneumatic connection 3, 4	G $\frac{1}{4}$		G $\frac{1}{2}$		
Design	Branching module				
	Branching module with non-return function				
Type of mounting	Via accessories				
	In-line installation				
Assembly position	Any <sup>1)</sup>				
Pressure display	Via pressure sensor for displaying output pressure via LCD display and electrical output				
	Via pressure sensor for displaying output pressure via operational status indicator and electrical output				
	Via pressure gauge for displaying output pressure				

1) The branching module must be mounted vertically when combined with a pressure sensor as condensate must not collect in the pressure sensor.  
- | - Note: This product conforms with the ISO 1179-1 standard and the ISO 228-1 standard.

Standard nominal flow rate $q_{nN^1}$ [l/min]					
Size	MS4		MS6		
Pneumatic connection	G $\frac{1}{8}$	G $\frac{1}{4}$	G $\frac{1}{4}$	G $\frac{3}{8}$	G $\frac{1}{2}$
Standard					
In main flow direction 1 $\rightarrow$ 2	1,800	4,600	4,200	9,200	14,700
Outlet at top	1,600	1,500	6,000	4,700	4,400
Outlet at bottom	1,700	1,500	6,400	4,800	4,600
With non-return function					
In main flow direction 1 $\rightarrow$ 2	1,200	1,750	3,200	5,500	6,000
Outlet at top	500	500	2,700	2,900	3,100
Outlet at bottom	500	500	2,800	3,200	3,300

1) Measured at  $p_1 = 6$  bar and  $p_2 = 5$  bar,  $\Delta p = 1$  bar

## Branching modules MS4/MS6-FRM, MS series

Technical data

Operating and environmental conditions								
Variant	Standard		Non-return function I		Pressure switch X/Y/M12		Pressure sensor AD...	
Size	MS4	MS6	MS4	MS6	MS4	MS6	MS4	MS6
Operating pressure [bar]	0 ... 14	0 ... 20	0 ... 10	0 ... 20	0 ... 12	0 ... 12	0 ... 10	0 ... 10
Operating medium	Compressed air		Compressed air		Compressed air		Filtered compressed air, lubricated or unlubricated, grade of filtration 40 µm	
Ambient temperature [°C]	-10 ... +60		-10 ... +60		-10 ... +60		0 ... +50	
Temperature of medium [°C]	-10 ... +60		-10 ... +60		-10 ... +60		0 ... +50	
Storage temperature [°C]	-10 ... +60		-10 ... +60		-10 ... +60		-10 ... +60	
Corrosion resistance class CRC <sup>1)</sup>	2							

1) Corrosion resistance class 2 according to Festo standard 940 070

Components requiring moderate corrosion resistance. Externally visible parts with primarily decorative surface requirements which are in direct contact with a normal industrial environment or media such as coolants or lubricating agents.

Weight [g]		
Size	MS4	MS6
Branching module	165	458
Branching module with non-return function I	160	400
Branching module with pressure sensor AD...	255	528
Branching module with pressure switch X/Y/M12	405	736

### Materials

Sectional view

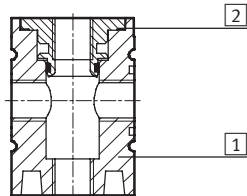

Branching module	
1	Housing Die-cast aluminium
2	Threaded insert Aluminium
Note on materials Free of copper and PTFE (not with variants AG or AD...)	

## Branching modules MS4/MS6-FRM, MS series

Technical data

**FESTO**

### Dimensions – Standard

Download CAD data → [www.festo.com](http://www.festo.com)

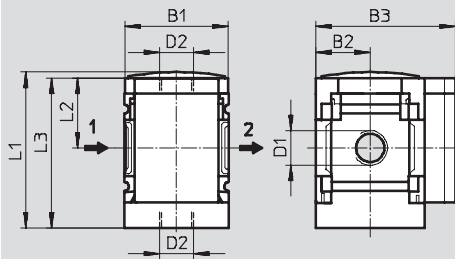

→ Flow direction

Type	B1	B2	B3	D1	D2	L1	L2	L3
MS4-FRM-1/8	40	21	54	G1/8	G1/4	60.4	27	58
MS4-FRM-1/4				G1/4				
MS6-FRM-1/4	62	31	76	G1/4	G1/2	87.2	39	84.5
MS6-FRM-3/8				G3/8				
MS6-FRM-1/2				G1/2				

• | - Note: This product conforms with the ISO 1179-1 standard and the ISO 228-1 standard.

### Dimensions – Pressure gauge alternatives

Download CAD data → [www.festo.com](http://www.festo.com)

Integrated MS pressure gauge with standard scale AG or red-green scale RG, display unit [bar]

Adapter plate A8/A4 for EN pressure gauge 1/8/1/4, without pressure gauge

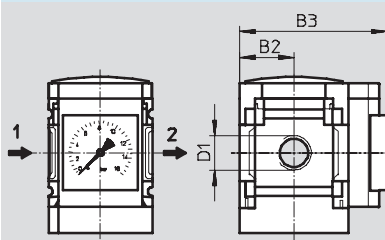

→ Flow direction

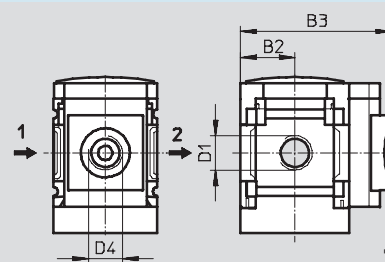

→ Flow direction

Type	B2	B3	D1	D4
MS4-FRM-1/8-...-AG	21	57	G1/8	-
MS4-FRM-1/4-...-AG			G1/4	
MS4-FRM-1/8-...-RG	21	58.5	G1/8	-
MS4-FRM-1/4-...-RG			G1/4	
MS4-FRM-1/8-...-A8	21	58.5	G1/8	G1/8
MS4-FRM-1/4-...-A8			G1/4	
MS4-FRM-1/8-...-A4	21	58.5	G1/8	G1/4
MS4-FRM-1/4-...-A4			G1/4	
MS6-FRM-1/4-...-AG	31	77	G1/4	-
MS6-FRM-3/8-...-AG			G3/8	
MS6-FRM-1/2-...-AG			G1/2	
MS6-FRM-1/4-...-RG	31	78.5	G1/4	-
MS6-FRM-3/8-...-RG			G3/8	
MS6-FRM-1/2-...-RG			G1/2	
MS6-FRM-1/4-...-A4	31	78.5	G1/4	G1/4
MS6-FRM-3/8-...-A4			G3/8	
MS6-FRM-1/2-...-A4			G1/2	

• | - Note: This product conforms with the ISO 1179-1 standard and the ISO 228-1 standard.

**New**  
**Variant AD7 ... AD10**

**Branching modules MS4/MS6-FRM, MS series**

Technical data

**FESTO**

**Dimensions – Pressure gauge alternatives**

Download CAD data → [www.festo.com](http://www.festo.com)

Pressure sensor with LCD display AD1 ... AD4

Technical data → Internet: [sde1](http://sde1)

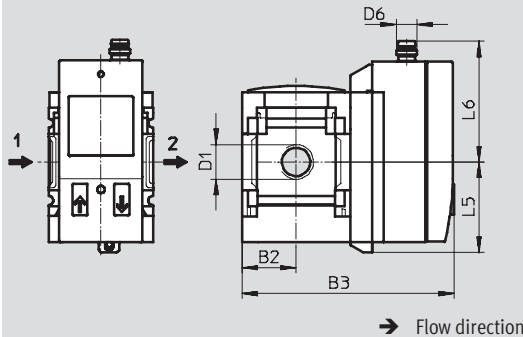

Variant AD1:  
SDE1-D10-G2-MS-L-P1-M8 with 3-pin plug M8x1, 1 switch output PNP

Variant AD3:  
SDE1-D10-G2-MS-L-PI-M12 with 4-pin plug M12x1, 1 switch output PNP and 4 ... 20 mA analogue

Variant AD2:  
SDE1-D10-G2-MS-L-N1-M8 with 3-pin plug M8x1, 1 switch output NPN

Variant AD4:  
SDE1-D10-G2-MS-L-NI-M12 with 4-pin plug M12x1, 1 switch output NPN and 4 ... 20 mA analogue

→ Flow direction

Pressure sensor without LCD display (operational status indicator only) AD7 ... AD10

Technical data → Internet: [sde5](http://sde5)

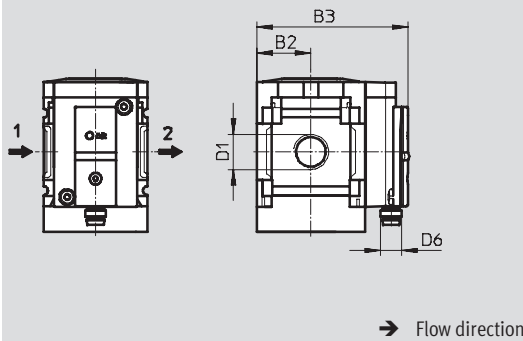

Variant AD7:  
SDE5-D10-O-...-P-M8 with 3-pin plug M8x1, threshold value comparator, 1 switching output PNP, N/O contact

Variant AD9:  
SDE5-D10-O3-...-P-M8 with 3-pin plug M8x1, window comparator, 1 switching output PNP, N/O contact

Variant AD8:  
SDE5-D10-C-...-P-M8 with 3-pin plug M8x1, threshold value comparator, 1 switching output PNP, N/C contact

Variant AD10:  
SDE5-D10-C3-...-P-M8 with 3-pin plug M8x1, window comparator, 1 switching output PNP, N/C contact

→ Flow direction

Type	B2	B3	D1	D6	L5	L6
MS4-FRM-1/8-...-AD1/AD2	21	82.6	G1/8	M8x1	35.1	46.7
MS4-FRM-1/4-...-AD1/AD2			G1/4			
MS4-FRM-1/8-...-AD3/AD4	21	82.6	G1/8	M12x1	35.1	55.8
MS4-FRM-1/4-...-AD3/AD4			G1/4			
MS4-FRM-1/8-...-AD7/AD8/AD9/AD10	21	59	G1/8	M8x1	-	-
MS4-FRM-1/4-...-AD7/AD8/AD9/AD10			G1/4			
MS6-FRM-1/4-...-AD1/AD2	31	103	G1/4	M8x1	35.1	46.7
MS6-FRM-3/8-...-AD1/AD2			G3/8			
MS6-FRM-1/2-...-AD1/AD2			G1/2			
MS6-FRM-1/4-...-AD3/AD4	31	103	G1/4	M12x1	35.1	55.8
MS6-FRM-3/8-...-AD3/AD4			G3/8			
MS6-FRM-1/2-...-AD3/AD4			G1/2			
MS6-FRM-1/4-...-AD7/AD8/AD9/AD10	31	79	G1/4	M8x1	-	-
MS6-FRM-3/8-...-AD7/AD8/AD9/AD10			G3/8			
MS6-FRM-1/2-...-AD7/AD8/AD9/AD10			G1/2			

• | Note: This product conforms with the ISO 1179-1 standard and the ISO 228-1 standard.

## Branching modules MS4/MS6-FRM, MS series

Technical data

**FESTO**

### Dimensions – Pressure switch

Pressure switch with adjustable pressure switching point X/Y/M12

Download CAD data → [www.festo.com](http://www.festo.com)

Technical data → Internet: pev-1/4

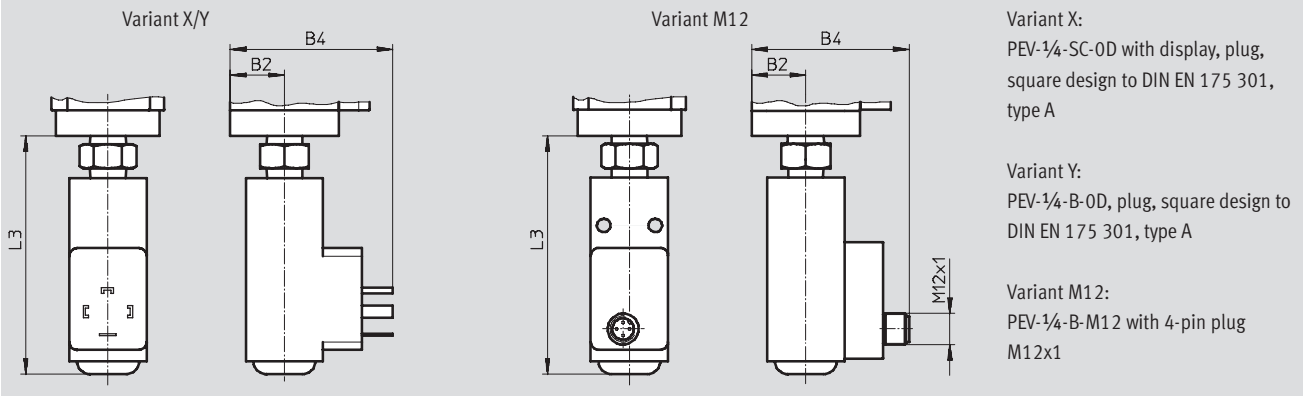

Type	B2	B4	L3
MS4-FRM-...-X/Y	21	63	92.3
MS4-FRM-...-M12	21	61	92.3
MS6-FRM-...-X/Y	31	73	99.5
MS6-FRM-...-M12	31	71	99.5

### Ordering data

Size	Connection	Standard		With integrated non-return function		With pressure switch PEV-1/4-B-0D (variant Y)	
		Part No.	Type	Part No.	Type	Part No.	Type
MS4	G1/8	529559	MS4-FRM-1/8-1)	536965	MS4-FRM-1/8-1)	529560	MS4-FRM-1/8-Y1)
	G1/4	529555	MS4-FRM-1/4-1)	536966	MS4-FRM-1/4-1)	529556	MS4-FRM-1/4-Y1)
MS6	G1/4	529857	MS6-FRM-1/4-1)	536967	MS6-FRM-1/4-1)	529858	MS6-FRM-1/4-Y1)
	G3/8	529861	MS6-FRM-3/8-1)	536968	MS6-FRM-3/8-1)	529862	MS6-FRM-3/8-Y1)
	G1/2	529853	MS6-FRM-1/2-1)	536969	MS6-FRM-1/2-1)	529854	MS6-FRM-1/2-Y1)

1) Free of copper and PTFE

**New**  
Variant AD7 ... AD10

**Branching modules MS4/MS6-FRM, MS series**



Ordering data – Modular products

**M** Mandatory data →

Module No.	Series	Size	Function	Connection size
527703 527676	MS	4 6	FRM	1/8, 1/4, 3/8, 1/2, AGA, AGB, AGC, AGD, AGE
<b>Order example</b>				
527676	MS	6	- FRM	- 3/8

Ordering table						
Grid dimension	[mm]	40	62	Condi- tions	Code	Enter code
<b>M</b>	Module No.	527703	527676			
	Series	Standard			MS	MS
	Size	4	6		...	
	Function	Branching module			-FRM	-FRM
	Connection size	Thread G1/8	-		-1/8	
		Thread G1/4	Thread G1/4		-1/4	
		-	Thread G3/8		-3/8	
		-	Thread G1/2		-1/2	
		Connecting plate G1/8	-		-AGA	
		Connecting plate G1/4	Connecting plate G1/4		-AGB	
		Connecting plate G3/8	Connecting plate G3/8		-AGC	
		-	Connecting plate G1/2		-AGD	
	-	Connecting plate G3/4		-AGE		

Transfer order code

	MS		-	FRM		-	
--	----	--	---	-----	--	---	--



## Branching modules MS4/MS6-FRM, MS series

Ordering data – Modular products

**FESTO**

Options					
Auxiliary function	Pressure gauge alternatives	Alternative pressure gauge scale	Pressure switch	Type of mounting	Alternative flow direction
I	AG, A8, A4, RG, AD1 ... AD4, AD7 ... AD10	PSI MPA	X Y M12	WP WPM WB WBM	Z
-	- <b>AG</b>	- <b>PSI</b>	- <b>M12</b>	- <b>WB</b>	- <b>Z</b>

Ordering table							
Grid dimension	[mm]	40	62	Condi- tions	Code	Enter code	
0	Auxiliary function	With integrated non-return function			-I		
	Pressure gauge alternatives	MS pressure gauge, bar (with adapter plate)	MS pressure gauge, bar		-AG		
		Adapter plate for EN pressure gauge 1/8, without pressure gauge	-		-A8		
		Adapter plate for EN pressure gauge 1/4, without pressure gauge	-		-A4		
		Integrated pressure gauge, red-green scale	-		-RG		
		Pressure sensor with display, plug M8, 1 switching output PNP, 3-pin	-		[1]	-AD1	
		Pressure sensor with display, plug M8, 1 switching output NPN, 3-pin	-		[1]	-AD2	
		Pressure sensor with display, plug M12, 1 switching output PNP, 4-pin, analogue output 4 ... 20 mA	-		[1]	-AD3	
		Pressure sensor with display, plug M12, 1 switching output NPN, 4-pin, analogue output 4 ... 20 mA	-		[1]	-AD4	
		Pressure sensor without display, plug M8, threshold value comparator, PNP, N/O contact	-		[1]	-AD7	
		Pressure sensor without display, plug M8, threshold value comparator, PNP, N/C contact	-		[1]	-AD8	
	Pressure sensor without display, plug M8, window comparator, PNP, N/O contact	-		[1]	-AD9		
	Pressure sensor without display, plug M8, window comparator, PNP, N/C contact	-		[1]	-AD10		
	Alternative pressure gauge scale	psi	-	[2]	-PSI		
		MPa	-	[2]	-MPA		
	Pressure switch	Pressure switch PEV with display, plug socket, EN 175301, type A, square	-	[3]	-X		
		Pressure switch PEV without display, plug socket, EN 175301, type A, square	-	[3]	-Y		
		Pressure switch PEV without display, plug socket, round, M12, 4-pin	-	[3]	-M12		
	Type of mounting	Mounting bracket	-	[4]	-WP		
		Mounting bracket	-	[4]	-WPM		
		Mounting bracket	-			-WB	
		Mounting bracket	-			-WBM	
	Alternative flow direction	Flow direction from right to left			-Z		

[1] **AD1 ... AD4, AD7 ... AD10**  
Measuring range max. 10 bar

[2] **PSI, MPA** Only with pressure gauge alternative AG or RG

[3] **X, Y, M12** Max. permissible supply pressure P1 = 12 bar.

[4] **WP, WPM** Only with connecting plate AGA, AGB, AGC, AGD or AGE

Transfer order code



- [ ] - [ ] - [ ] - [ ] - [ ] - [ ]

## Distributor blocks MS4/MS6-FRM-FRZ, MS series

### Technical data

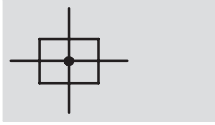
#### Function



-  - Flow rate  
2,900 ... 14,600 l/min
-  - Temperature range  
-10 ... +60 °C
-  - Operating pressure  
0 ... 20 bar



#### - - Note

The distributor block MS4/6-FRM-FRZ has a half grid dimension width.

- Pneumatic manifold with 4 connections
- Outlet top and bottom
- Can be used as an intermediate distributor for varying air qualities
- Can be used as an intermediate distributor between two pressure regulators with large rotary knob with pressure gauge on size MS4

General technical data		
Size	MS4	MS6
Pneumatic connection 1, 2, 3, 4	G $\frac{1}{4}$	G $\frac{1}{2}$
Design	Branching module	
Type of mounting	Via accessories	
	In-line installation	
Assembly position	Any	

-  - Note: This product conforms with the ISO 1179-1 standard and the ISO 228-1 standard.

Standard nominal flow rate $q_{nN}^{1)}$ [l/min]		
Size	MS4	MS6
Pneumatic connection	G $\frac{1}{4}$	G $\frac{1}{2}$
In main flow direction 1 $\rightarrow$ 2	4,050	14,600
Outlet at top	3,250	10,400
Outlet at bottom	2,900	9,850

1) Measured at  $p_1 = 6$  bar and  $p_2 = 5$  bar,  $\Delta p = 1$  bar

Operating and environmental conditions		
Size	MS4	MS6
Operating pressure [bar]	0 ... 14	0 ... 20
Operating medium	Compressed air	
Ambient temperature [°C]	-10 ... +60	
Temperature of medium [°C]	-10 ... +60	
Storage temperature [°C]	-10 ... +60	
Corrosion resistance class CRC <sup>1)</sup>	2	

1) Corrosion resistance class 2 to Festo standard 940 070  
Components subject to moderate corrosion stress. Externally visible parts with primarily decorative surface requirements which are in direct contact with a normal industrial environment or media such as coolants or lubricating agents.

Weight [g]		
Size	MS4	MS6
Distributor block	60	163

# Distributor blocks MS4/MS6-FRM-FRZ, MS series

Technical data

## Materials

Sectional view

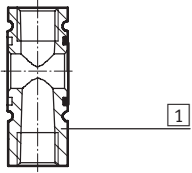

Distributor block		
1	Housing	Die-cast aluminium
Note on materials		Free of copper and PTFE

## Dimensions

Download CAD data → [www.festo.com](http://www.festo.com)

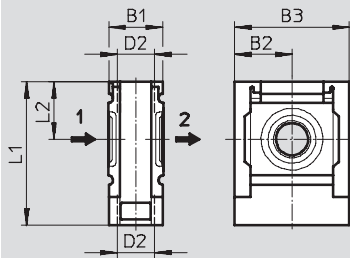

→ Flow direction

Type	B1	B2	B3	D2	L1	L2
MS4-FRM-FRZ	20	21	42	G $\frac{1}{4}$	52.5	21
MS6-FRM-FRZ	31	31	62	G $\frac{1}{2}$	76.5	31

- | - Note: This product conforms with the ISO 1179-1 standard and the ISO 228-1 standard.

## Ordering data

Size	Connection	Part No.	Type
MS4	G $\frac{1}{4}$	549336	MS4-FRM-FRZ <sup>1)</sup>
MS6	G $\frac{1}{2}$	549337	MS6-FRM-FRZ <sup>1)</sup>

1) Free of copper and PTFE

# Branching modules MS12-FRM, MS series

Peripherals overview

## Branching modules MS12-FRM

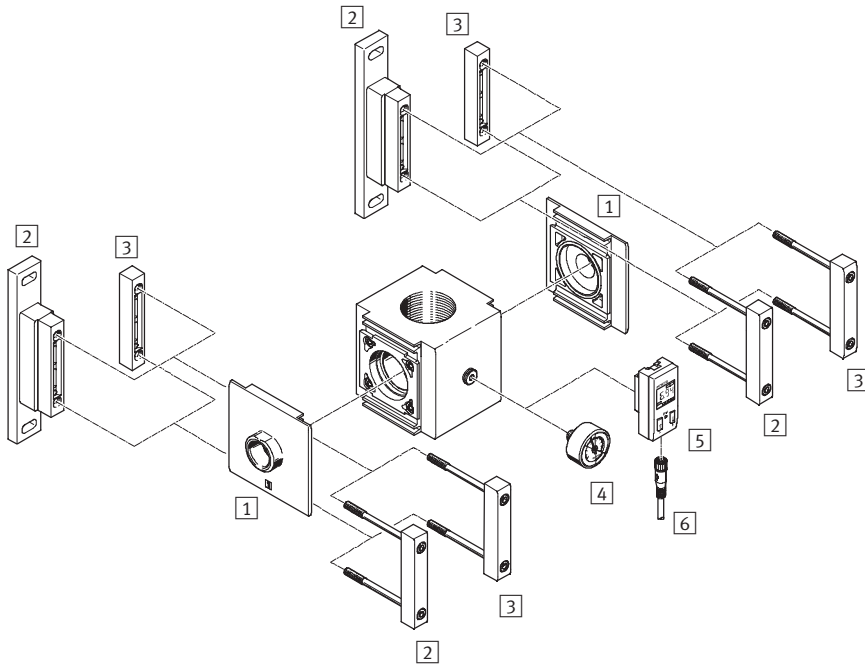

-  - Note  
 Additional accessories:  
 - Module connector for combination with size MS9 → Internet: armv

### Mounting attachments and accessories

		→ Page/Internet
1	Connecting plate MS12-AG...	ms12-ag
2	Mounting bracket MS12-WP	ms12-wp
3	Module connector MS12-MV	ms12-mv
4	Pressure gauge MA	25
5	Pressure sensor SDE1-...-R14/R18	25
6	Connecting cable NEBU-M8...-LE3/NEBU-M8...-LE4/NEBU-M12...-LE3	25

# Branching modules MS12-FRM, MS series

Type codes

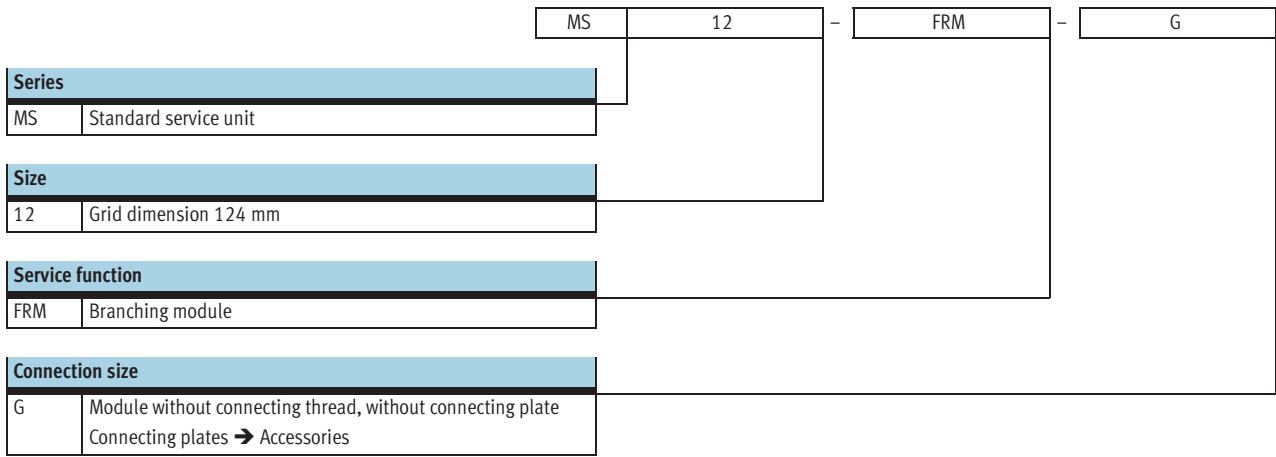

Further variants can be ordered using the modular system → 24

- Connecting plates
- Type of mounting



# Branching modules MS12-FRM, MS series

Technical data

FESTO

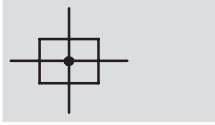
Function



-  - Flow rate  
25,000 ... 42,000 l/min
-  - Temperature range  
-10 ... +60 °C
-  - Operating pressure  
0 ... 21 bar



- Pneumatic manifold with 4 connections
- Attachment facility for auxiliary modules
- Outlet top and bottom
- Can be used as an intermediate distributor for varying air qualities

## General technical data

Pneumatic connection 1, 2 <sup>1)</sup>	G1	G1¼	G1½	G2
Pneumatic connection 3	G2			
Pneumatic connection 4	G1			
Design	Branching module			
Type of mounting	Via accessories			
	In-line installation			
Assembly position	Any			

- 1) Dependent on connecting plate selected, must be ordered separately as an accessory → Internet: ms12-ag  
 -  Note: This product conforms with the ISO 1179-1 standard and the ISO 228-1 standard.

## Standard nominal flow rate $q_{nN}^{1)}$ [l/min]

In main flow direction 1 → 2	25,000 ... 42,000
------------------------------	-------------------

- 1) Dependent on connecting plate selected, must be ordered separately as an accessory → Internet: ms12-ag  
 Measured at  $p_1 = 6$  bar and  $p_2 = 5$  bar,  $\Delta p = 1$  bar

## Operating and environmental conditions

Operating pressure	[bar]	0 ... 21
Operating medium		Compressed air
Ambient temperature	[°C]	-10 ... +60
Temperature of medium	[°C]	-10 ... +60
Storage temperature	[°C]	-10 ... +60
Corrosion resistance	CRC <sup>1)</sup>	2

- 1) Corrosion resistance class 2 according to Festo standard 940 070  
 Components requiring moderate corrosion resistance. Externally visible parts with primarily decorative surface requirements which are in direct contact with a normal industrial environment or media such as coolants or lubricating agents.

# Branching modules MS12-FRM, MS series

Technical data

Weights [g]	
Branching module	3,000

## Materials

Sectional view

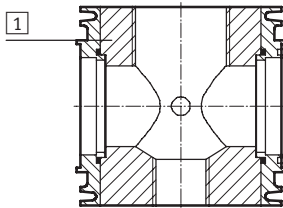

Branching module		
1	Body	Die-cast aluminium
-	Seals	Nitrile rubber
	Note on materials	Free of copper and PTFE

## Dimensions – Standard

Download CAD data → [www.festo.com](http://www.festo.com)

1) G $\frac{1}{4}$  Female thread in body, sealed with cover plate by default

→ Flow direction

Type	B1	B2	B3	D2	D3	D4	L1	L2
MS12-FRM	124	124	134	G2	G1	G $\frac{1}{4}$	122	61

-||- Note: This product conforms with the ISO 1179-1 standard and the ISO 228-1 standard.

Ordering data			
Size	Connection	Part No.	Type
MS12	G1 ... G2 <sup>1)</sup>	<b>541681</b>	<b>MS12-FRM-G<sup>2)</sup></b>

1) Connecting plate must be ordered separately as an accessory → Internet: ms12-ag

2) Free of copper and PTFE

-||- Note: This product conforms with the ISO 1179-1 standard and the ISO 228-1 standard.

# Branching modules MS12-FRM, MS series

Ordering data – Modular products

M Mandatory data					O Options
Module No.	Series	Size	Function	Connection size	Type of mounting
535035	MS	12	FRM	AGF AGG AGH AGI G	WP
<b>Order example</b>					
535035	MS	12	- FRM	- AGF	- WP

Ordering table					
Grid dimension	[mm]	124	Condi- tions	Code	Enter code
M	Module No.	535035			
	Series	Standard		MS	MS
	Size	12		12	12
	Function	Branching module		-FRM	-FRM
	Connection size	Connecting plate G1		-AGF	
		Connecting plate G1¼		-AGG	
		Connecting plate G1½		-AGH	
		Connecting plate G2		-AGI	
		Module without connecting thread, without connecting plate		-G	
O	Type of mounting	Mounting bracket	1	-WP	

1 WP Only with connecting plate AGF, AGG, AGH or AGI.

Transfer order code

535035	MS	12	- FRM	-	-
--------	----	----	-------	---	---





# Branching modules/distributor blocks MS-FRM, MS series

Accessories

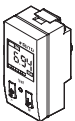
Ordering data – Pressure gauge MA					
	Nominal size	Pneumatic connection	Display range		Part No. Type
			[bar]	[psi]	
	Pressure gauge MA, DIN EN 837-1 <span style="float:right">Technical data → Internet: ma</span>				
	40	G1/4	0 ... 16	0 ... 232	183901 MA-40-16-G1/4-EN
	Pressure gauge MA, DIN EN 837-1, with red-green range <span style="float:right">Technical data → Internet: ma</span>				
	40	R1/8	0 ... 16	–	525726 MA-40-16-R1/8-E-RG
	50	R1/4	0 ... 16	–	525729 MA-50-16-R1/4-E-RG

Ordering data – Pressure sensor SDE1					
	Pneumatic connection	Electrical output	Electrical connection	Display	Part No. Type
	Male thread R1/8	1 switching output PNP	M8x1, 3-pin	LCD	192026 SDE1-D10-G2-R18-C-P1-M8
			M8x1, 3-pin	Illuminated LCD	529970 SDE1-D10-G2-R18-L-P1-M8
			M12x1, 3-pin	Illuminated LCD	534064 SDE1-D10-G2-R18-L-P1-M12
		2 switching outputs PNP	M8x1, 4-pin	LCD	192027 SDE1-D10-G2-R18-C-P2-M8
			M8x1, 4-pin	Illuminated LCD	529971 SDE1-D10-G2-R18-L-P2-M8
			1 switching output PNP and 0 ... 10 V analogue	M8x1, 4-pin	LCD
	M8x1, 4-pin	Illuminated LCD		529972 SDE1-D10-G2-R18-L-PU-M8	
	Male thread R1/4	1 switching output PNP	M8x1, 3-pin	LCD	192028 SDE1-D10-G2-R14-C-P1-M8
			M8x1, 3-pin	Illuminated LCD	529967 SDE1-D10-G2-R14-L-P1-M8
			M12x1, 3-pin	Illuminated LCD	534157 SDE1-D10-G2-R14-L-P1-M12
		2 switching outputs PNP	M8x1, 4-pin	LCD	192029 SDE1-D10-G2-R14-C-P2-M8
			M8x1, 4-pin	Illuminated LCD	529968 SDE1-D10-G2-R14-L-P2-M8
1 switching output PNP and 0 ... 10 V analogue		M8x1, 4-pin	LCD	529957 SDE1-D10-G2-R14-C-PU-M8	
	M8x1, 4-pin	Illuminated LCD	529969 SDE1-D10-G2-R14-L-PU-M8		

Ordering data – Connecting cable NEBU-M8				
	Electrical connection	Number of wires	Cable length [m]	Part No. Type
	M8x1, straight socket	3	2.5	541333 NEBU-M8G3-K-2.5-LE3
			5	541334 NEBU-M8G3-K-5-LE3
		4	2.5	541342 NEBU-M8G4-K-2.5-LE4
			5	541343 NEBU-M8G4-K-5-LE4
	M8x1, angled socket	3	2.5	541338 NEBU-M8W3-K-2.5-LE3
			5	541341 NEBU-M8W3-K-5-LE3
		4	2.5	541344 NEBU-M8W4-K-2.5-LE4
			5	541345 NEBU-M8W4-K-5-LE4

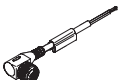
Ordering data – Connecting cable NEBU-M12				
	Electrical connection	Number of wires	Cable length [m]	Part No. Type
	M12x1, straight socket	3	2.5	541363 NEBU-M12G5-K-2.5-LE3
			5	541364 NEBU-M12G5-K-5-LE3
		4	2.5	550326 NEBU-M12G5-K-2.5-LE4
			5	541328 NEBU-M12G5-K-5-LE4
	M12x1, angled socket	3	2.5	541367 NEBU-M12W5-K-2.5-LE3
			5	541370 NEBU-M12W5-K-5-LE3
		4	2.5	550325 NEBU-M12W5-K-2.5-LE4
			5	541329 NEBU-M12W5-K-5-LE4

## Branching modules/distributor blocks MS-FRM, MS series

FESTO

Accessories

Ordering data – Angled socket PEV					Technical data → Internet: pev-1/4	
	Description	Operating voltage range	Electrical connection	Switching status display	Part No.	Type
	For PEV-1/4-...-OD	15 ... 30 V DC	4-pin	Yellow LED	164274	PEV-1/4-WD-LED-24
		≤ 230 V AC ≤ 180 V DC	4-pin	Yellow LED	164275	PEV-1/4-WD-LED-230

Ordering data – Plug socket MSSD					Technical data → Internet: mssd-c-4p	
	Description	Operating voltage range	Electrical connection	Type of mounting: cable connection	Part No.	Type
	For PEV-1/4-...-OD	≤ 250 V AC/DC	3-pin	Clamping screws	171157	MSSD-C-4P

Ordering data – Double nipple ESK					
	Description	Pneumatic connection		Part No.	Type
	Adjustable for angular compensation • For retrofitting pressure switch PEV to branching module MS-FRM	R1/4	R1/4	151521	ESK-1/4-1/4
			R1/2	534153	ESK-1/4-1/2